



sunlite[®]



BULB CATALOG 2019

ABOUT US

Sunshine Lighting was founded in 1980 by Morty Kohn as a one man operation. It evolved into a multinational enterprise, growing at a rapid pace to become one of the leading lighting manufacturers in the United States. Sunshine Lighting takes great pride in maintaining the personal relationship with each customer.

In 1996 Sunshine Lighting began developing and manufacturing the Sunlite® brand, producing many lighting technologies, including a vast selection of LED, Compact Fluorescent, Incandescent, HID, Halogen, Decorative, Miniature, Specialty, Stage and Studio lamps as well as a large collection of electrical supplies and Light Fixtures. The Sunlite® brand has gained a reputation of quality and affordability and keeps up with the latest technologies to provide the most advanced products in the lighting industry.

In today's fast paced world, we understand that availability is vital. With our 100,000+ square feet of warehouse space we stock more than 13,000 different products so that we are able to provide immediate service to all our customers. We also carry all major brands including Osram-Sylvania, General Electric (GE), Philips, Ushio, Universal and many others.

Through customer interaction and feedback, we work tirelessly to introduce new and innovative products to the marketplace as well as constantly improving our existing line of items to meet the high expectations our customers have come to rely on us for.

Our dedicated team of technical and product specialists ensures that our products are designed with safety and the environment in mind. Many of our products carry the Underwriters Laboratories and/or Energy Star certifications. Sunlite® is also partnered with the U.S. Department of Energy (DOE) Lighting Facts program, the Design Lights Consortium (DLC), and the American Lighting Association (ALA) among others.

For product inquiries or to place an order, please contact us at:

TOLL FREE PHONE: **800.605.BULB**

VISIT: **www.sunlite.com**

For general information: info@sunlite.com

Sales department: sales@sunlite.com

To request a catalog: catalog@sunlite.com

New York

744 Clinton Street
Brooklyn, NY 11231
t: 718.768.7000
f: 718.768.0970

Florida

3698 1/2 NW 16th Street Bay C
Lauderhill, FL 33311
t: 954.316.6130
f: 954.316.6019

sunlite®

TABLE OF CONTENTS

Introduction	04-05
Filament Style	06-11
Shabbulb/General Purpose Blinker <i>Sunlite Exclusive</i>	
Appliance Bulbs	11
General Purpose Lamps	
<i>Standard Bulbs</i>	12-15
<i>Colored Bulbs</i>	15
<i>Blacklight Bulb</i> <i>Sunlite Exclusive</i>	15
Globes	16
Chandeliers	17
Reflector Lamps	18-22
Colored Reflector Lamps	22-23
Indicator Lamps / Sign Lamp	24
Night Lights	25
Tubulars	25
Colored Tubulars	26
Elevator Bulbs	26
Halogen Alternative Specialty	27
Hospitality Series	28
Plant Growth Lamps	28
Decorative Lamps	29-30
Linestra Lamps	32
Plug-In Lamps	32-33
Advanced Bypass Dual End Tubes	
<i>T5</i>	34
<i>T8</i>	35
<i>T8 U-Bend</i>	36
Plug and Play Tubes	
<i>T5</i>	37
<i>T8</i>	38
<i>T8 (Economy Type)</i>	39
<i>T8 U-Bend</i>	39
High Lumen Lamps	
<i>Corn Cobs</i>	40
<i>High Bay Lamps</i>	41
UFO Fixtures & Lamps	42

INTRODUCTION

What are LEDs?

LED stands for **light emitting diode**. LED lighting products produce light approximately 90% more efficiently than incandescent light bulbs. LEDs are found in all sorts of applications, such as the indicator light in your remote control, the numbers in a digital clock, the picture displayed on a television screen, home lighting or practically any other lighting application.

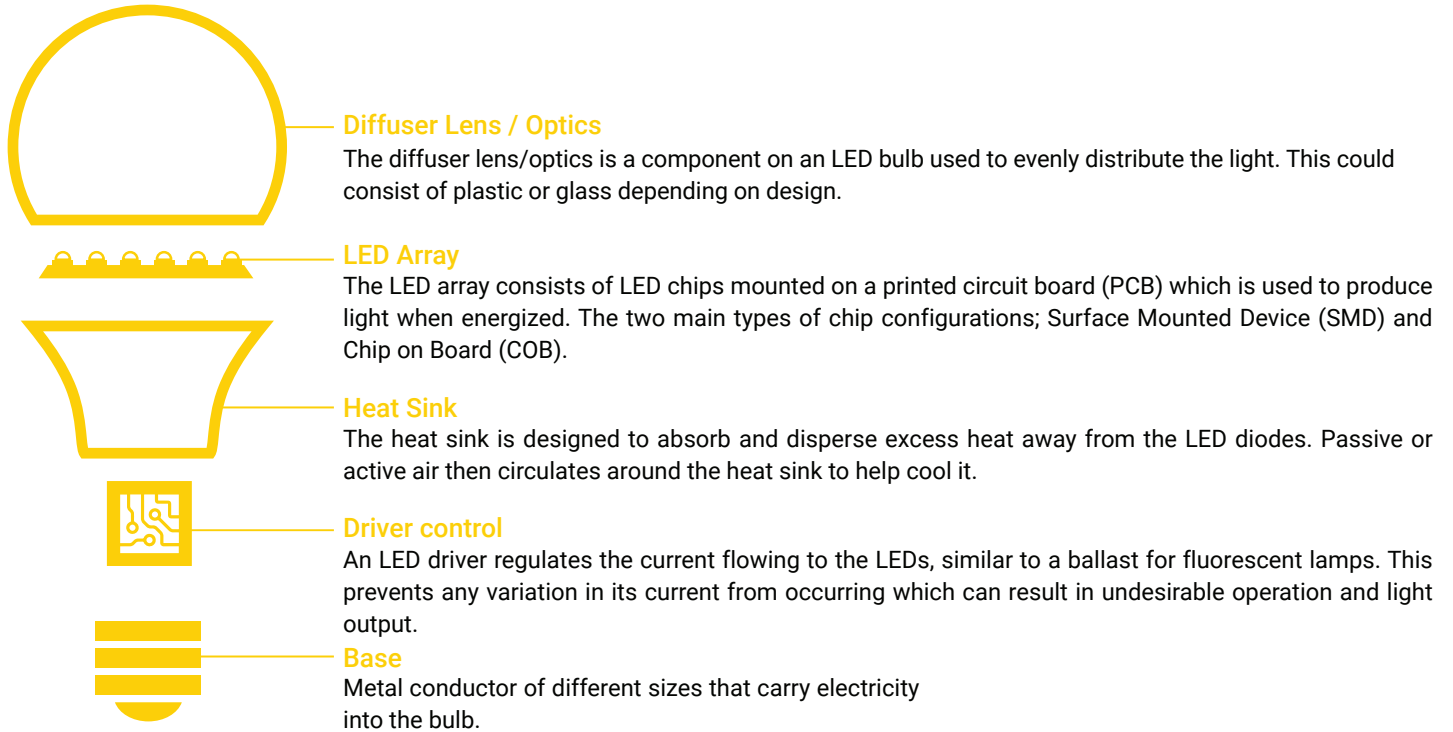

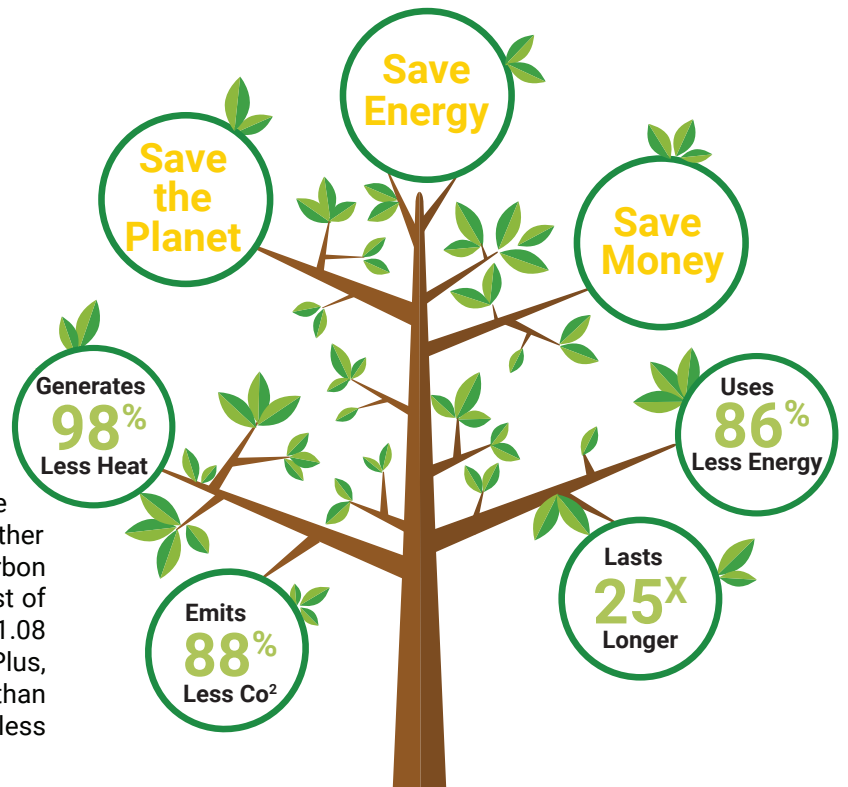

Why Switch to LED Bulbs?

LEDs save you money and make your home or business more environmentally friendly. LEDs use less energy to produce the same light output as other alternatives, which means you'll reduce your carbon footprint and energy costs. In fact, the annual cost of powering the average 800 lumens LED bulb is \$1.08 vs. \$7.23 per year for an incandescent bulb. Plus, since LEDs last at least 25 times longer than incandescent bulbs, you're changing bulbs way less often, thus saving on the costs of replacements.

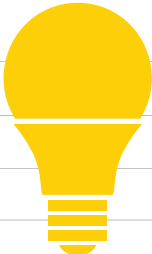

LED vs. INCANDESCENT vs. CFL

CATEGORIES	LED		CFL		INCANDESCENT
WATTS	9W		14W		60W
KILOWATTS	9.855-kW/yr.		15.33kW/yr.		65.7-kW/yr.
LUMENS	800		800		800
LIFE SPAN	50,000 hrs.		8,000 hrs.		1,200 hrs.
ANNUAL COST	\$1.08/yr*		\$1.69/yr*		\$7.23/yr*

* Based on 3 hours a day and \$0.11 per kWh

Buy Lumens, Not Watts!

The old days of selecting light bulbs by watts are over. Use our lumens-to-watts conversion chart to choose the right LED bulb for your application.

Incandescent Bulb	LED Bulb
40W 450 Lumens	5W 450 Lumens
60W 800 Lumens	9W 800 Lumens
75W 1100 Lumens	11W 1100 Lumens
100W 1600 Lumens	15W 1600 Lumens
150W 2600 Lumens	25W 2600 Lumens

What is CRI?

The color rendering index (CRI) is a measurement of light that affects how the color of an object appears. The higher the CRI value the more accurate and vibrant colors appear, with a CRI of 90-100 being considered excellent, while a score below 70 is generally considered poor.





Excellent	Good	Poor
100 - 90	85 - 70	70 - 0



Color Temperature

Light appearance, measured in Kelvins (K), refers to a lamp's emitted color. A warm white color temperature of 2700K-3000K will emit a very yellowish light that creates a relaxing feel and is most similar to the light emitted by an incandescent bulb. Light sources with a color temperature in the 3500K-4000K range, bring out cooler tones which are most suited for kitchens and bathrooms and provides a great balance between warm and cooler colors. Bulbs in the 5000K-6500K range, emit a more bluish light which closely resembles actual daylight and is great for kitchen, office, and other industrial and work spaces.

Color Temperature (KELVIN)

2700-3000K	3500K	4000K	5000K	6500K
				
WARM WHITE	NEUTRAL WHITE	COOL WHITE	SUPER WHITE	DAYLIGHT

Filament Style

Standard A-Type

- A19
- Medium Screw (E26)
- >80 CRI
- 120 Volts



A



B

Silver Bowl

PKG	Item#	Description	Watt	Eq.W	Lumen	LPW	Color	Kelvin	Hours	Carton	MOL (IN)	Features
A	Box 80456-SU	A19/LED/FS/6W/D/CL/22K	6	25	430	72	Warm White	2200K	25000	12/96	4.25	DIM
	Box 80188-SU	A19/LED/FS/6W/D/CL/27K	6	40	600	100	Warm White	2700K	15000	6/24	4.25	DL, DIM
	Box 80223-SU	A19/LED/FS/6W/D/CL/40K	6	40	600	100	Cool White	4000K	15000	6/24	4.25	DL, DIM
	Box 81109-SU	A19/LED/FS/5W/D/CL/50K	5	40	500	100	Super White	5000K	15000	6/24	4.25	DIM, EXF
Silver Bowl												
B	Box 80497-SU	A19/LED/FS/SB/6W/D/CL/22K	6	40	450	75	Warm White	2200K	25000	12/96	4.25	DIM, SB

Filament Style

Party & Decorative

- A19
- Medium Screw (E26)
- Transparent colors
- 120 Volts



Box



2PACK



Green



Yellow



Red



Orange



Purple

PKG	Item#	Description	Watt	Eq.W	Lumen	LPW	Color	Kelvin	Hours	Carton	MOL (IN)	Features
Box	81080-SU	A19/LED/FS/4.5W/TB/2PK	4.5	-	-	-	Blue	-	15000	3/12	4	DL, DIM, EXF
Box	81083-SU	A19/LED/FS/4.5W/TG/2PK	4.5	-	-	-	Green	-	15000	3/12	4	DL, DIM, EXF
Box	81084-SU	A19/LED/FS/4.5W/TY/2PK	4.5	-	-	-	Yellow	-	15000	3/12	4	DL, DIM, EXF
Box	81082-SU	A19/LED/FS/4.5W/TR/2PK	4.5	-	-	-	Red	-	15000	3/12	4	DL, DIM, EXF
Box	81085-SU	A19/LED/FS/4.5W/TO/2PK	4.5	-	-	-	Orange	-	15000	3/12	4	DL, DIM, EXF
Box	81081-SU	A19/LED/FS/4.5W/TP/2PK	4.5	-	-	-	Purple	-	15000	3/12	4	DL, DIM, EXF



Filament Style

Standard A-Type

- S19
- Medium Screw (E26)
- >80 CRI
- 120 Volts

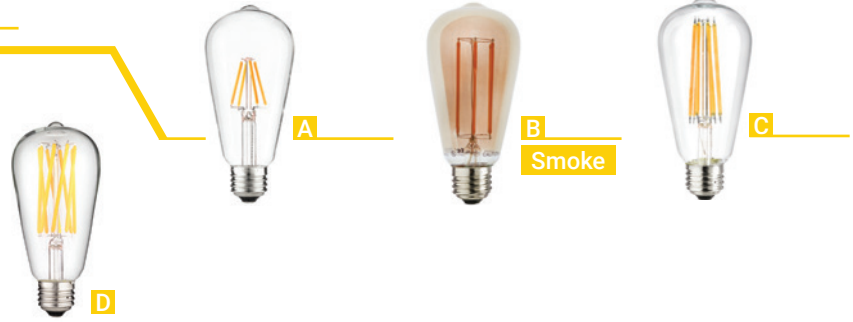

PKG	Item#	Description	Watt	Eq. W	Lumen	LPW	Color	Kelvin	Hours	Carton	MOL (IN)	Features	
25 Watt Equivalent													
A	Box	80460-SU	S19/LED/FS/3W/D/CL/22K	3	25	240	80	Warm White	2200K	25000	6/24	5.51	DIM
	Box	80150-SU	S19/LED/FS/4W/D/CL/27K	4	25	350	88	Warm White	2700K	25000	6/24	2.51	DL, DIM
40 Watt Equivalent													
B	Box	80894-SU	S19/LED/FS/6W/D/AMBER/22K/LF	6	40	450	75	Amber Light	2200K	15000	6/24	5.39	DL, DIM, LF
C	Box	80461-SU	S19/LED/FS/6W/D/CL/22K/LF	6	40	600	100	Warm White	2200K	15000	6/24	5.51	DL, DIM, LF
	Box	80890-SU	S19/LED/FS/6W/D/CL/27K/LF	6	40	600	100	Warm White	2700K	15000	6/24	5.51	DL, DIM, LF
60 Watt Equivalent													
D	Box	80602-SU	S19/LED/FS/8W/CL/22K/LF	8	60	880	110	Warm White	2200K	15000	6/24	4.25	DIM, LF

Filament Style

Torpedo Tip Chandelier

- B11
- >80 CRI
- 120 Volts

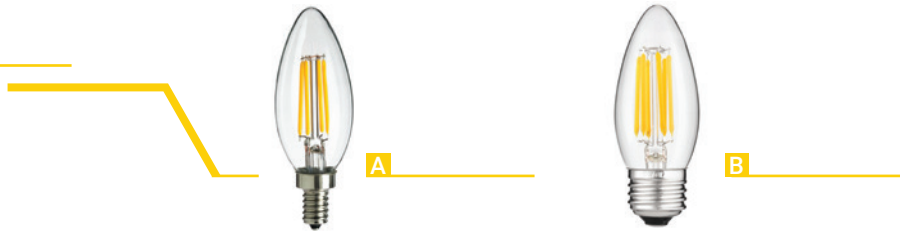

PKG	Item#	Description	Watt	Eq. W	Lumen	LPW	Color	Kelvin	Hours	Carton	MOL (IN)	Features	
Candelabra Screw (E12)													
A	Card	80446-SU	CTC/LED/FS/4W/E12/D/CL/18K/CD2	4	25	250	63	Warm White	1800K	15000	24/96	3.93	DIM
	Box	80663-SU	CTC/LED/FS/4W/E12/D/CL/27K	4	40	400	100	Warm White	2700K	15000	6/24	1.38	DL, DIM
	Box	80664-SU	CTC/LED/FS/5W/E12/D/CL/27K	5	60	600	120	Warm White	2700K	15000	6/24	1.38	DL, DIM
	Box	81103-SU	CTC/LED/FS/5W/E12/D/CL/30K	5	60	600	120	Warm White	3000K	15000	6/24	1.38	DL, DIM
	Box	81110-SU	CTC/LED/FS/5W/E12/D/CL/40K	5	60	630	126	Cool White	4000K	15000	6/24	1.38	DL, DIM
	Box	81111-SU	CTC/LED/FS/5W/E12/D/CL/50K	5	60	650	130	Super White	5000K	15000	6/24	1.38	DL, DIM
Candelabra Screw (E12) 220-277 Volt													
	Box	80445-SU	CTC/LED/FS/5W/E12/D/CL/27K	5	40	450	90	Warm White	2700K	15000	12/48	2.83	DIM
Medium Screw (E26)													
B	Card	80428-SU	ETC/LED/FS/4W/E26/D/CL/27K/CD2	4	40	350	88	Warm White	2700K	15000	24/96	3.93	DIM
	Box	80658-SU	ETC/LED/FS/5W/E26/D/CL/27K	5	60	600	120	Warm White	2700K	15000	6/24	3.58	DL, DIM
	Box	81106-SU	ETC/LED/FS/6W/E26/D/CL/50K	6	60	600	100	Super White	5000K	15000	6/24	3.42	DL, DIM

Filament Style

Flame Tip Chandelier

- CA11
- >80 CRI
- 120 Volts



A



B

PKG	Item#	Description	Watt	Eq.W	Lumen	LPW	Color	Kelvin	Hours	Carton	MOL (IN)	Features	
Candelabra Screw (E12)													
A	Card	80447-SU	CFC/LED/FS/4W/E12/D/CL/18K/CD2	4	25	250	63	Warm White	1800K	15000	24/96	3.93	DIM
	Box	80634-SU	CFC/LED/FS/4W/E12/D/CL/27K	4	40	400	100	Warm White	2700K	15000	12/48	4.25	DL, DIM
	Card	80633-SU	CFC/LED/FS/4W/E12/D/CL/27K/CD2	4	40	400	100	Warm White	2700K	15000	6/24	4.25	DL, DIM
	Box	80662-SU	CFC/LED/FS/5W/E12/D/CL/27K	5	60	600	120	Warm White	2700K	15000	6/24	4.72	DL, DIM
	Box	81104-SU	CFC/LED/FS/6W/E12/D/CL/40K	6	60	600	100	Cool White	4000K	15000	6/24	4.72	DL, DIM, ES
	Box	80674-SU	CFC/LED/FS/5W/E12/D/CL/50K	5	60	650	130	Super White	5000K	15000	6/24	1.38	DL, DIM
Medium Screw (E26)													
B	Card	80449-SU	EFC/LED/FS/4W/E26/D/CL/18K/CD2	4	40	320	80	Clear White	1800K	15000	24/96	4.25	DL, DIM
	Box	80421-SU	EFC/LED/FS/4W/E26/D/E/CL/27K	4	40	400	100	Warm White	2700K	15000	6/24	4.25	DL, DIM, ES

Filament Style

Designer Lamps

- >80 CRI
- 120 Volts



A



B



C
AMBER



D



E

PKG	Item#	Description	Watt	Eq. W	Lumen	LPW	Color	Kelvin	Hours	Carton	MOL (IN)	Beam Spread	Features	
Medium Screw (E26)														
A	Box	80469-SU	DIAMOND/LED/FS/6W/D/CL/22K	6	25	480	80	Warm White	2200K	25000	24	6.5	360°	DIM
B	Box	80616-SU	LU/LED/FS/6W/D/CL/22K	6	25	430	72	Warm White	2200K	15000	10/60	2.08	360°	DIM
C	Box	80459-SU	FLATDIAMOND/LED/FS/6W/D/AMBER/22K	6	25	450	75	Warm White	2200K	25000	6/24	6.5	360°	DL, DIM
Mogul Screw (E39) E26 Adapter Included														
D	Box	80484-SU	G48/LED/FS/SWIRL	10	100	750	75	Warm White	2200K	25000	4	5.9	360°	DIM
E	Box	80485-SU	CHIMNEY/LED/FS/12W/D/22K	10	100	750	75	Warm White	2200K	25000	4	5.9	360°	DIM

DIM = Dimmable

ES = Energy Star

DL = Rated Damp Location

LF = Long Filament

SB= Silver Bowl

Filament Style

Globe

- >80 CRI
- 120 Volts



A

B



C

D

E

F

G

Silver Bowl

Silver Bowl

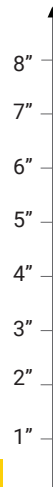

PKG	Item#	Description	Watt	Eq.W	Lumen	LPW	Color	Kelvin	Hours	Carton	MOL (IN)	Features
G16 Medium Screw (E26)												
A	Box 80454-SU	G16/LED/FS/3W/E26/D/CL/22K	3	25	240	80	Warm White	2200K	25000	6/24	2.95	DIM
	Box 81112-SU	G16/LED/FS/3W/E26/D/CL/27K	3	25	250	83	Warm White	2700K	15000	6/24	3.34	DIM
G16.5 Candelabra Screw (E12)												
B	Box 81125-SU	G16.5/LED/FS/3W/E12/D/CL/27K	3	25	250	83	Warm White	2700K	15000	6/24	3.08	DIM
	Box 81126-SU	G16.5/LED/FS/3W/E12/D/CL/30K	3	25	300	100	Warm White	3000K	15000	6/24	3.08	DIM
	Box 81127-SU	G16.5/LED/FS/3W/E12/D/CL/50K	3	40	400	133	Super White	5000K	15000	6/24	3.08	DIM
G25 Medium Screw (E26)												
C	Box 80464-SU	G25/LED/FS/4W/D/CL/22K	4	25	300	75	Warm White	2200K	15000	6/24	3.15	DIM
	Box 80465-SU	G25/LED/FS/6W/D/CL/22K/LF	6	60	480	80	Warm White	2200K	25000	6/24	4.65	DIM, LF
	Box 81115-SU	G25/LED/FS/6W/D/CL/27K/LF	6	75	600	100	Warm White	2700K	15000	6/24	4.53	DIM, LF
	Box 81116-SU	G25/LED/FS/6W/D/CL/40K/LF	6	100	650	108	Cool White	4000K	15000	6/24	4.53	DIM, LF
	Box 81117-SU	G25/LED/FS/6W/D/CL/50K/LF	6	100	700	117	Super White	5000K	15000	6/24	4.53	DIM, LF
D	Box 80494-SU	G25/LED/FS/SB/6W/D/CL/27K	6	60	530	88	Warm White	2700K	15000	6/24	3.14	DIM, SB
G30 Medium Screw (E26)												
E	Box 80450-SU	G30/LED/FS/6W/D/CL/22K	6	40	420	70	Warm White	2200K	15000	6/24	5.31	DL, DIM
	Box 80600-SU	G30/LED/FS/8W/CL/22K/LF	8	100	880	110	Warm White	2200K	15000	48	3.74	DIM, LF
	Box 80601-SU	G30/LED/FS/8W/CL/27K/LF	8	100	880	110	Warm White	2700K	15000	6/24	5.43	DIM, LF
G40 Medium Screw (E26)												
F	Box 80467-SU	G40/LED/FS/8W/D/CL/22K/LF	8	80	880	110	Warm White	2200K	15000	6/24	6.61	DIM, LF
	Box 80472-SU	G40/LED/FS/8W/D/CL/27K/LF	8	100	880	110	Warm White	2700K	15000	6/24	7.09	DIM, LF
Silver Bowl												
G	Box 80506-SU	G40/LED/FS/SB/7W/CL/27K	7	75	600	86	Warm White	2700K	15000	6/24	6.89	DIM, SB

Filament Style

Tubular

- >80 CRI
- 120 Volts

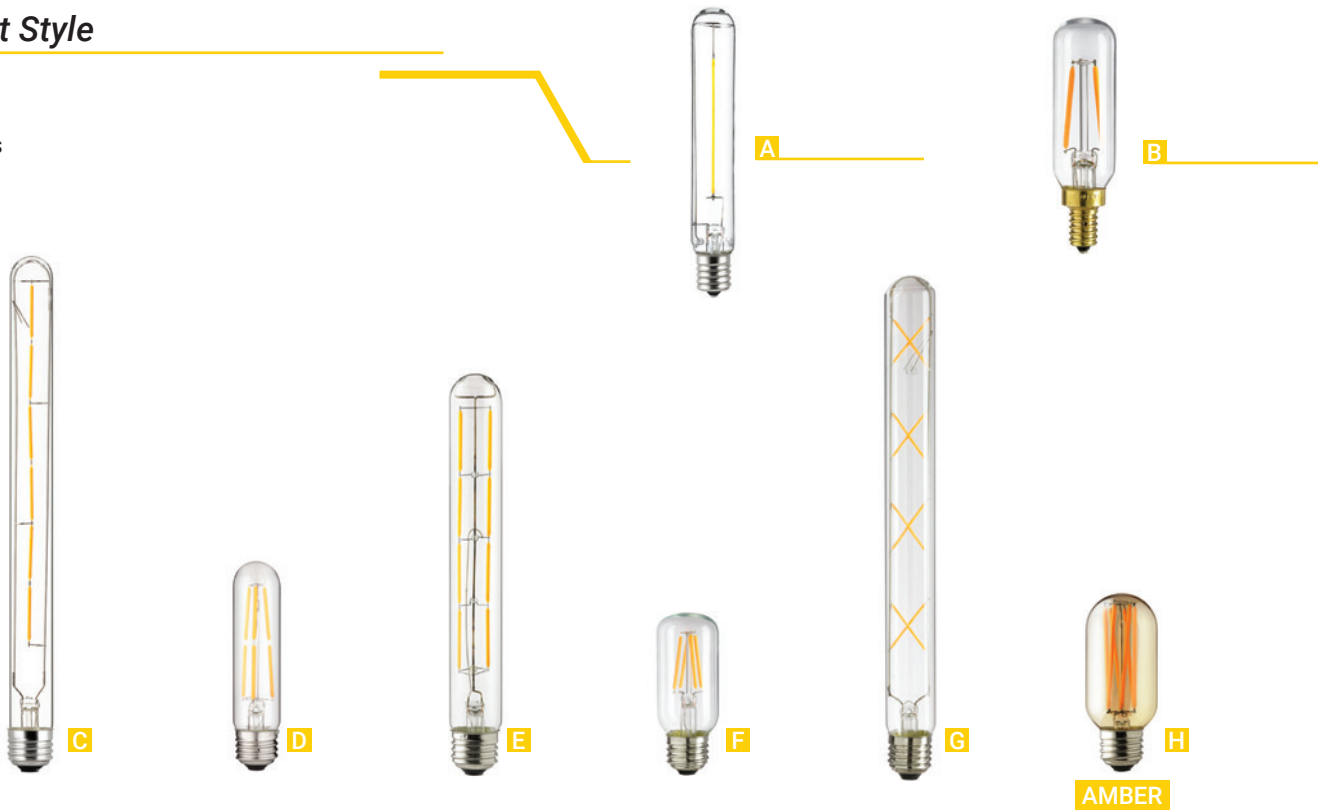

AMBER

PKG	Item#	Description	Watt	Eq.W	Lumen	LPW	Color	Kelvin	Hours	Carton	MOL (IN)	Features
T6 Intermediate Screw (E17)												
A	Card	81074-SU T6.5/LED/FS/2W/E17/CL/27K/139MM/CD	2	25	180	90	Warm White	2700K	15000	6/24	5.47	DL
T8 Candelabra Screw (E12)												
B	Box	80501-SU T8/LED/FS/1.8W/E12/D/CL/22K/85MM	1.8	20	120	67	Warm White	2200K	15000	12	3.35	DIM
	Box	80502-SU T8/LED/FS/1.8W/E12/D/CL/27K/85MM	1.8	20	130	72	Warm White	2700K	15000	12	3.35	DIM
T8 Medium Screw (E26)												
C	Box	80482-SU T8/LED/FS/5W/E26/D/CL/27K/214MM	5	40	430	86	Warm White	2700K	15000	10/50	8.42	DL, DIM
	Box	80489-SU T8/LED/FS/5W/E26/D/CL/22K/300MM	5	40	450	90	Warm White	2200K	15000	10/50	11.81	DL, DIM
T10 Medium Screw (E26)												
D	Box	80610-SU T10/LED/FS/2W/E26/CL/22K/126MM	2	25	200	100	Warm White	2200K	15000	12/48	4.96	DIM
	Box	80612-SU T10/LED/FS/6W/E26/CL/22K/128MM	6	25	380	63	Warm White	2200K	15000	12/48	5.03	DIM
	Box	80611-SU T10/LED/FS/6W/E26/CL/27K/128MM	6	40	600	100	Warm White	2700K	15000	12	5.03	DIM
E	Box	80614-SU T10/LED/FS/6W/E26/CL/22K/222MM	6	40	450	75	Warm White	2200K	25000	12/48	8.74	DIM
T12 Medium Screw (E26)												
F	Box	80458-SU T12/LED/FS/3W/E26/D/CL/22K/104MM	3	25	240	80	Warm White	2200K	15000	24	4.09	DIM
	Box	80892-SU T12/LED/FS/3W/E26/D/CL/27K/100MM	3	25	320	107	Warm White	2700K	15000	6/24	3.93	DIM
G	Box	80488-SU T12/LED/FS/6W/E26/D/CL/22K/300MM	6	40	480	80	Warm White	2200K	25000	10/50	11.81	DL, DIM
T14 Medium Screw (E26)												
H	Box	80606-SU T14/LED/FS/6W/22K/AMBER/107MM	6	25	400	67	Amber Light	2200K	25000	12/48	4.21	DIM
	Box	80608-SU T14/LED/FS/6W/22K/AMBER/127MM	6	25	400	67	Amber Light	2200K	25000	12/48	5	DIM

DIM = Dimmable ES = Energy Star DL = Rated Damp Location

Filament Style

Sign Colored

- Medium Screw (E26)
- 120 Volts

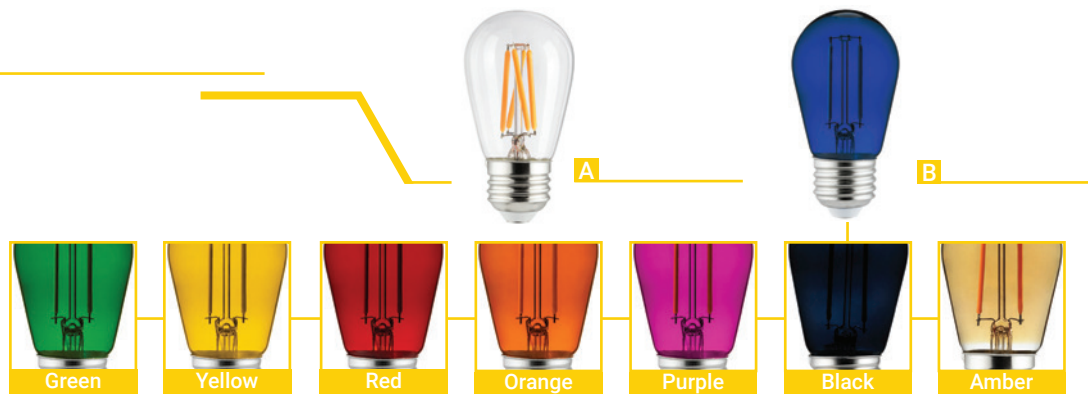

PKG	Item#	Description	Watt	Eq.W	Lumen	LPW	Color	Kelvin	Hours	Carton	MOL (IN)	Features	
S11 Medium Screw (E26)													
A	Box	80462-SU	S11/LED/FS/3W/D/CL/22K	3	25	240	80	Warm White	2200K	25000	6/24	3.46	DIM
S14 Medium Screw (E26)													
B	Box	81089-SU	S14/LED/FS/2W/TB	2	-	-	-	Blue	-	15000	6/24	3.27	DL, DIM
	Box	81088-SU	S14/LED/FS/2W/TG	2	-	-	-	Green	-	15000	6/24	3.27	DL, DIM
	Box	81086-SU	S14/LED/FS/2W/TY	2	-	-	-	Yellow	-	15000	6/24	3.27	DL, DIM
	Box	81092-SU	S14/LED/FS/2W/TR	2	-	-	-	Red	-	15000	6/24	3.27	DL, DIM
	Box	81090-SU	S14/LED/FS/2W/TO	2	-	-	-	Orange	-	15000	6/24	3.27	DL, DIM
	Box	81087-SU	S14/LED/FS/2W/TP	2	-	-	-	Purple	-	15000	6/24	3.27	DL, DIM
	Box	81091-SU	S14/LED/FS/2W/TBL	2	-	-	-	Black	-	15000	6/24	3.27	DL, DIM
	Box	81093-SU	S14/LED/FS/2W/A	2	-	-	-	Amber Light	-	15000	6/24	3.27	DL, DIM

Sunlite Exclusive

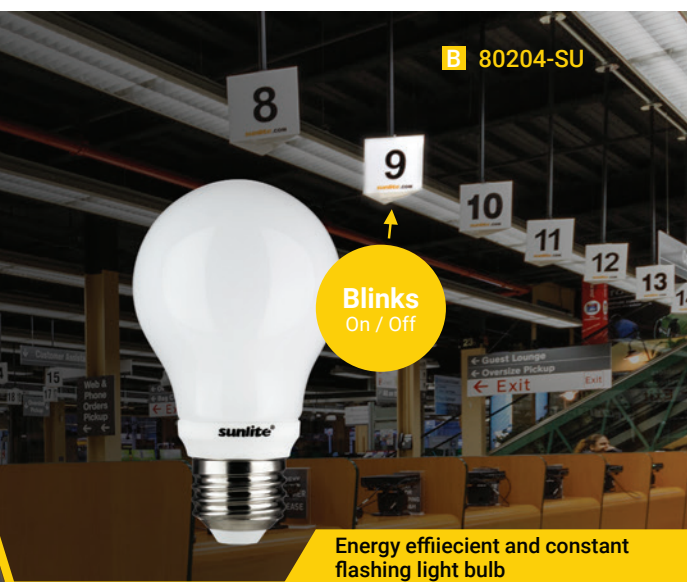

- Medium Screw (E26)
- 80 CRI
- 120 Volts

PKG	Item#	Description	Watt	Eq.W	Lumen	LPW	Color	Kelvin	Hours	Carton	MOL (IN)	Features	
A	Box	81140-SU	A19/LED/7W/SHAB/E27/30K	7	40	450	64	Warm White	3000K	10000	12	4.52	DL, Hand Dimming
B	Box	80204-SU	A19/LED/5W/BL/WW	5	40	500	100	Warm White	3000K	25000	12/48	4.33	Blinks On/Off

Appliance Bulbs

25 Watt Equivalent

- A15
- 80 CRI
- 120 Volts



PKG	Item#	Description	Watt	Eq.W	Lumen	LPW	Color	Kelvin	Hours	Carton	MOL (IN)	Features	
Medium Screw (E26)													
A	Box	80134-SU	A15/LED/4.5W/D/CL/30K	4.5	25	300	67	Warm White	3000K	25000	6/24	3.3	DL, DIM
B	Box	80177-SU	A15/LED/4.5W/D/FR/30K	4.5	25	300	67	Warm White	3000K	25000	6/24	3.3	DL, DIM
European (E14)													
C	Box	80187-SU	A15/LED/4.5W/E14/D/FR/30K	4.5	25	300	67	Warm White	3000K	25000	6/24	3.54	DL, DIM

General Purpose Lamps

40 Watt Equivalent

- A19
- Medium Screw (E26)
- >80 CRI
- 120 Volts



PKG	Item#	Description	Watt	Eq.W	Lumen	LPW	Color	Kelvin	Hours	Carton	MOL (IN)	Features
Box	88233-SU	A19/LED/6W/E/D/27K	6	40	450	82	Warm White	2700K	25000	6	4.15	DL, DIM, ES, EXF
Box	88348-SU	A19/LED/6W/E/D/40K	6	40	450	82	Cool White	4000K	25000	6/24	4.15	DL, DIM, ES
Box	88332-SU	A19/LED/6W/E/D/50K	6	40	480	80	Super White	5000K	25000	6/24	4.15	DIM, ES, EXF

General Purpose Lamps

60 Watt Equivalent

- A19
- Medium Screw (E26)
- >80 CRI
- 120 Volts



PKG	Item#	Description	Watt	Eq.W	Lumen	LPW	Color	Kelvin	Hours	Carton	MOL (IN)	Features
Dimmable												
Box	88393-SU	A19/LED/9.5W/E/D/27K	9.5	60	800	84	Warm White	2700K	25000	6/24	4.15	DL, DIM, ES, EXF
Box	88390-SU	A19/LED/9.5W/E/D/30K	9.5	60	800	84	Warm White	3000K	25000	6/24	4.15	DL, DIM, ES, EXF
Box	80683-SU	A19/LED/9W/E/D/40K	9	60	800	89	Cool White	4000K	25000	6/24	4.15	DL, DIM, ES, EXF
Box	88392-SU	A19/LED/9W/E/D/50K	9	60	800	89	Super White	5000K	25000	6/24	4.15	DL, DIM, ES, EXF

DIM = Dimmable **ES** = Energy Star **DL** = Rated Damp Location **EXF** = Rated for Enclosed Fixture

General Purpose Lamps *Continued*

60 Watt Equivalent

- A19
- Medium Screw (E26)
- >80 CRI
- 120 Volts



12 Pack Contractor



3 Pack

PKG	Item#	Description	Watt	Eq.W	Lumen	LPW	Color	Kelvin	Hours	Carton	MOL (IN)	Features
Non-Dimmable												
Box	80682-SU	A19/LED/9W/30K/3PK	9	60	800	89	Warm White	3000K	15000	6/24	4.15	DL, EXF
Card	80711-SU	A19/LED/9W/30K/CD	9	60	800	89	Warm White	3000K	15000	12/48	4.15	DL, EXF
Box	81021-SU	A19/LED/9W/30K/12PK	9	60	800	89	Warm White	3000K	11000	12	4.15	DL, EXF
Box	80688-SU	A19/LED/9W/40K/3PK	9	60	800	89	Cool White	4000K	15000	6	4.15	DL, EXF
Box	80739-SU	A19/LED/9W/50K/3PK	9	60	800	89	Super White	5000K	15000	6/24	4.15	DL, EXF
Card	80726-SU	A19/LED/9W/50K/CD	9	60	800	89	Super White	5000K	15000	12/48	4.15	DL, EXF
Box	81022-SU	A19/LED/9W/50K/12PK	9	60	800	89	Super White	5000K	11000	12	4.15	DL, EXF
Card	80717-SU	A19/LED/9W/65K/CD	9	60	800	89	Daylight	6500K	15000	12/48	4.15	DL, EXF
Box	80681-SU	A19/LED/9W/65K/3PK	9	60	800	89	Daylight	6500K	15000	6/24	4.15	DL, EXF
Box	81023-SU	A19/LED/9W/65K/12PK	9	60	800	89	Daylight	6500K	11000	12	4.15	DL, EXF
220 Volts												
Box	80119-SU	A19/LED/10W/50K/220V	10	60	800	80	Super White	5000K	20000	6/24	4.15	DL

General Purpose Lamps

75 Watt Equivalent

- A19
- Medium Screw (E26)
- >80 CRI
- 120 Volts



Card

PKG	Item#	Description	Watt	Eq.W	Lumen	LPW	Color	Kelvin	Hours	Carton	MOL (IN)	Features
Dimmable												
Box	88309-SU	A19/LED/11W/E/D/27K	11	75	1100	100	Warm White	2700K	25000	6	4.15	DL, DIM, ES, EXF
Box	88306-SU	A19/LED/12W/ES/D/30K	12	75	1100	92	Warm White	3000K	25000	6/24	4.15	DL, DIM, ES, EXF
Box	88307-SU	A19/LED/12W/ES/D/40K	12	75	1100	92	Cool White	4000K	25000	12/48	4.15	DL, DIM, ES, EXF
Box	88308-SU	A19/LED/12W/ES/D/50K	12	75	1100	92	Super White	5000K	25000	12/48	4.15	DL, DIM, ES, EXF
Non-Dimmable												
Card	80687-SU	A19/LED/11W/30K/CD	11	75	1100	100	Warm White	3000K	15000	12	4.15	DL, EXF
Card	80684-SU	A19/LED/11W/65K/CD	11	75	1100	100	Daylight	6500K	15000	12/48	4.15	DL, EXF

General Purpose Lamps

75 Watt Equivalent

- A19
- Medium Screw (E26)
- >80 CRI
- 120 Volts



A



B

PKG	Item#	Description	Watt	Eq. W	Lumen	LPW	Color	Kelvin	Hours	Carton	MOL (IN)	Features	
Non-Dimmable 3 Pack													
A	Box	80859-SU	A19/LED/11W/30K/3PK	11	75	1100	100	Warm White	3000K	15000	6/24	4.15	DL, EXF
	Box	80834-SU	A19/LED/12W/40K/3PK	12	75	1100	83	Cool White	4000K	11000	6/24	4.15	DL, EXF
	Box	80854-SU	A19/LED/11W/50K/3PK	11	75	1100	100	Super White	5000K	15000	6/24	4.15	DL, EXF
	Box	80853-SU	A19/LED/11W/65K/3PK	11	75	1100	100	Daylight	6500K	15000	6/24	4.15	DL, EXF
Omni-Directional													
B	Box	80743-SU	A19/LED/12W/D/OD/50K	12	75	1100	92	Super White	5000K	25000	6/24	4.40	DL, DIM
	Box	80742-SU	A19/LED/12W/D/OD/65K	12	75	1100	92	Daylight	6500K	25000	6/24	4.40	DIM

General Purpose Lamps

100 Watt Equivalent

- Medium Screw (E26)
- 80 CRI
- 120 Volts



PKG	Item#	Description	Watt	Eq. W	Lumen	LPW	Color	Kelvin	Hours	Carton	MOL (IN)	Features	
Dimmable													
	Box	80724-SU	A21/LED/15W/D/E/27K	15	100	1600	107	Warm White	2700K	25000	6/24	5.15	DL, DIM, ES, EXF
	Box	80803-SU	A21/LED/15W/D/E/30K	15	100	1600	107	Warm White	3000K	25000	6/24	5.15	DL, DIM, ES, EXF
	Box	80804-SU	A21/LED/15W/D/E/40K	15	100	1600	107	Cool White	4000K	25000	6/24	5.15	DL, DIM, ES, EXF
	Box	80725-SU	A21/LED/15W/D/E/50K	15	100	1600	107	Super White	5000K	25000	6/24	5.15	DL, DIM, ES, EXF
	Box	80728-SU	A21/LED/15W/D/65K	15	100	1600	107	Daylight	6500K	25000	6/24	5.15	DL, DIM, EXF
Non-Dimmable													
	Card	80848-SU	A19/LED/14W/30K/CD	14	100	1500	107	Warm White	3000K	15000	12/48	4.15	DL, EXF
	Box	80937-SU	A19/LED/14W/30K/3PK	14	100	1500	107	Warm White	3000K	15000	6/24	4.15	DL, EXF
	Card	80858-SU	A19/LED/14W/50K/CD	14	100	1500	107	Super White	5000K	15000	12/48	4.15	DL, EXF
	Box	80938-SU	A19/LED/14W/50K/3PK	14	100	1500	107	Super White	5000K	11000	6/24	4.15	DL, EXF
	Card	80940-SU	A19/LED/14W/65K/CD	14	100	1500	107	Daylight	6500K	15000	12/48	4.15	DL, EXF
	Box	80939-SU	A19/LED/14W/65K/3PK	14	100	1500	107	Daylight	6500K	11000	6/24	4.15	DL, EXF

DIM = Dimmable ES = Energy Star DL = Rated Damp Location WL = Rated Wet Location WILD= Turtle Safe EXF = Rated for Enclosed Fixture

General Purpose Lamps

GU24 Base | 60 Watt Equivalent

- A19
- Twist & Lock (GU24)
- >80 CRI
- 120 Volts



PKG	Item#	Description	Watt	Eq.W	Lumen	LPW	Color	Kelvin	Hours	Carton	MOL (IN)	Features
Box	88320-SU	A19/GU24/LED/10W/D/E/27K	10	60	800	80	Warm White	2700K	15000	6/24	4.45	DL, DIM, ES
Box	88345-SU	A19/GU24/LED/10W/D/E/40K	10	60	800	80	Cool White	4000K	15000	6/24	4.45	DL, DIM, ES
Box	88346-SU	A19/GU24/LED/10W/D/E/50K	10	60	800	80	Super White	5000K	15000	6/24	4.45	DL, DIM, ES

General Purpose Colored

Party & Decorative

- A19
- Medium Screw (E26)
- >80 CRI
- 120 Volts



PKG	Item#	Description	Watt	Eq.W	Lumen	LPW	Color	Kelvin	Hours	Carton	MOL (IN)	Features
Box	80145-SU	A19/3W/B/LED	3	-	-	-	Blue	-	25000	6/24	4.27	DL
Box	80146-SU	A19/3W/G/LED	3	-	-	-	Green	-	25000	6/24	4.27	DL
Box	80147-SU	A19/3W/O/LED	3	-	-	-	Orange	-	25000	6/24	4.27	DL, WILD
Box	80148-SU	A19/3W/R/LED	3	-	-	-	Red	-	25000	6/24	4.27	DL, WILD
Box	80149-SU	A19/3W/Y/LED	3	-	-	-	Yellow	-	25000	6/24	4.27	DL
Box	80168-SU	A19/3W/P/LED	3	-	-	-	Pink	-	25000	6/24	4.27	DL
Box	80132-SU	A19/3W/PR/LED	3	-	-	-	Purple	-	25000	6/24	4.27	DL

Sunlite Exclusive

BLACK LIGHTS 365_{nm} LED

- A19
- Medium Screw (E26)
- 120 Volts



Identification & monetary validation. Forensic investigations.

Special effects, art illumination, UV painting, Halloween parties.

Night clubs, bars lighting, and other entertainment venues



Sunlite's LED Blacklight emits UV-A light at the sweet spot of 365nm thus ensuring only surfaces that fluoresce will illuminate. This combined with the low power consumption of LED technology and being maintenance free due to its long life makes this the ideal bulb to install wherever true UV-A light is needed.

PKG	Item#	Description	Watt	Eq.W	Lumen	LPW	Color	Kelvin	Hours	Carton	MOL (IN)	Features
Box	80114-SU	A19/LED/2W/BLB	2	-	-	-	UV Black Light	-	10000	12/24	4.21	365NM

Decorative Lamps

Globe

- >80 CRI
- 120 Volts



A



B



C

PKG	Item#	Description	Watt	Eq.W	Lumen	LPW	Color	Kelvin	Hours	Carton	Finish	MOL (IN)	Features	
G16 Medium Screw (E26)														
A	Box	80518-SU	G16/LED/5W/D/E26/CL/ES/27K	5	40	350	70	Warm White	2700K	25000	6/24	Clear	2.83	DIM, ES
	Box	80653-SU	G16/LED/5W/D/E26/FR/ES/27K	5	40	350	70	Warm White	2700K	25000	6/24	Frosted	2.83	DIM, ES
	Box	80548-SU	G16/LED/7W/D/E26/CL/ES/27K	7	60	500	71	Warm White	2700K	25000	6/24	Clear	3.25	DIM, ES
	Box	80549-SU	G16/LED/7W/D/E26/FR/ES/27K	7	60	500	71	Warm White	2700K	25000	6/24	Frosted	3.25	DIM, ES
G16.5 Candelabra Screw (E12)														
B	Box	80409-SU	G16.5/LED/5W/D/E12/CL/ES/27K	5	40	350	70	Warm White	2700K	25000	6/24	Clear	2.91	DIM, ES
	Box	80651-SU	G16.5/LED/5W/D/E12/FR/ES/27K	5	40	350	70	Warm White	2700K	25000	6/24	Frosted	2.91	DIM, ES
	Box	80544-SU	G16.5/LED/7W/D/E12/CL/ES/27K	7	60	500	71	Warm White	2700K	25000	6/24	Clear	2.91	DIM, ES
	Box	80545-SU	G16.5/LED/7W/D/E12/FR/ES/27K	7	60	500	71	Warm White	2700K	25000	6/24	Frosted	2.91	DIM, ES
G25 Medium Screw (E26)														
C	Box	80671-SU	G25/LED/7W/D/CL/ES/27K	7	60	500	71	Warm White	2700K	25000	6/24	Clear	4.4	DIM, ES
	Box	80672-SU	G25/LED/7W/D/FR/ES/27K	7	60	500	71	Warm White	2700K	25000	6/24	Frosted	4.4	DIM, ES
	Box	80673-SU	G25/LED/7W/D/FR/ES/30K	7	60	500	71	Warm White	3000K	15000	6/24	Frosted	4.4	DIM, ES





Decorative Lamps

Chandelier

- >80 CRI
- 120 Volts



PKG	Item#	Description	Watt	Eq.W	Lumen	LPW	Color	Kelvin	Hours	Carton	Finish	MOL (IN)	Features	
Torpedo Tip Candelabra Screw (E12)														
A	Box	80770-SU	CTC/LED/4.5W/E12/CL/D/ES/27K	4.5	40	300	67	Warm White	2700K	25000	6/24	Clear	3.85	DIM, ES
	Box	80771-SU	CTF/LED/4.5W/E12/FR/D/ES/27K	4.5	40	300	67	Warm White	2700K	25000	6/24	Frosted	3.85	DIM, ES
	Box	80774-SU	CTC/LED/7W/E12/CL/D/ES/27K	7	60	500	71	Warm White	2700K	25000	6/24	Clear	4.25	DIM, ES
	Box	80405-SU	CTF/LED/7W/E12/FR/D/ES/27K	7	60	500	71	Warm White	2700K	25000	6/24	Frosted	4.25	DIM, ES
Flame Tip Candelabra Screw (E12)														
B	Box	80772-SU	CFC/LED/5W/E12/CL/D/ES/27K	5	40	300	67	Warm White	2700K	25000	6/24	Clear	3.97	DIM, ES
	Box	80773-SU	CFF/LED/4.5W/E12/FR/D/ES/27K	4.5	40	300	67	Warm White	2700K	25000	6/24	Frosted	3.97	DIM, ES
	Box	80776-SU	CFC/LED/7W/E12/CL/D/ES/27K	7	60	500	71	Warm White	2700K	25000	6/24	Clear	4.48	DIM, ES
	Box	80424-SU	CFF/LED/7W/E12/FR/D/ES/27K	7	60	500	71	Warm White	2700K	25000	6/24	Frosted	4.48	DIM, ES
Torpedo Tip Medium Screw (E26)														
C	Box	80780-SU	ETC/LED/4.5W/E26/CL/D/ES/27K	4.5	40	300	67	Warm White	2700K	25000	6/24	Clear	3.81	DIM, ES
	Box	80343-SU	ETF/LED/4.5W/E26/FR/D/ES/27K	4.5	40	300	67	Warm White	2700K	25000	6/24	Frosted	3.82	DIM, ES
	Box	80790-SU	ETC/LED/7W/E26/CL/D/ES/27K	7	60	500	71	Warm White	2700K	25000	6/24	Clear	4.21	DIM, ES
	Box	80473-SU	ETF/LED/7W/E26/FR/D/ES/27K	7	60	500	71	Warm White	2700K	25000	6/24	Frosted	4.21	DIM, ES
Flame Tip Medium Screw (E26)														
D	Box	80479-SU	EFC/LED/4.5W/E26/CL/D/ES/27K	4.5	40	300	60	Warm White	2700K	25000	6/24	Clear	4.45	DIM,ES
	Box	80784-SU	EFC/LED/7W/E26/CL/D/ES/27K	7	60	500	71	Warm White	2700K	25000	6/24	Clear	4.45	DIM, ES
	Box	80477-SU	EFF/LED/7W/E26/FR/D/ES/27K	7	60	500	71	Warm White	2700K	25000	6/24	Frosted	4.45	DIM, ES
	Box	80475-SU	EFC/LED/7W/E26/CL/D/ES/27K	7	60	500	71	Warm White	2700K	25000	6/24	Clear	4.45	DIM, ES

MR11 Mini Reflector Lamps

Spotlight Lamps

- MR11
- 2-Pin (GU4)
- 80 CRI
- 12 Volts



PKG	Item#	Description	Watt	Eq.W	Lumen	LPW	Color	Kelvin	Hours	Carton	MOL (IN)	Beam Spread	Features
Box	81002-SU	MR11/LED/3W/12V/D/30K	3	35	240	80	Warm White	3000K	30000	12/48	1.65	25°	DIM

MR16 Mini Reflector Lamps

Flood Light

- MR16
- >80 CRI
- 12 Volts
- 120V



PKG	Item#	Description	Watt	Eq.W	Lumen	LPW	Color	Kelvin	Hours	Carton	MOL (IN)	Beam Spread	Features	
GU5.3 12V														
A	Box	81094-SU	MR16/LED/7W/12V/FL30/D/ES/27K	7	50	500	71	Warm White	2700K	25000	6/24	1.97	30°	DL, DIM, ES
	Box	81095-SU	MR16/LED/7W/12V/FL30/D/ES/30K	7	50	500	71	Warm White	3000K	25000	6/24	1.97	30°	DL, DIM, ES
	Box	81096-SU	MR16/LED/7W/12V/FL30/D/ES/40K	7	50	520	74	Cool White	4000K	25000	6/24	1.97	30°	DL, DIM, ES
	Box	81097-SU	MR16/LED/7W/12V/FL30/D/ES/50K	7	50	520	74	Super White	5000K	25000	6/24	1.97	30°	DL, DIM, ES
B	Box	80885-SU	MR16/LED/7W/12V/FL40/D/27K	7	35	550	79	Warm White	2700K	25000	6/24	1.9	40°	DL, DIM, EXF
	Box	80886-SU	MR16/LED/7W/12V/FL40/D/30K	7	50	600	86	Warm White	3000K	25000	6/24	1.9	40°	DL, DIM, EXF
	Box	80887-SU	MR16/LED/7W/12V/FL40/D/40K	7	50	600	86	Cool White	4000K	25000	6/24	1.9	40°	DL, DIM, EXF
	Box	80888-SU	MR16/LED/7W/12V/FL40/D/50K	7	50	600	86	Super White	5000K	25000	6/24	1.9	40°	DL, DIM, EXF
95 CRI GU5.3 12V														
	Box	80507-SU	MR16/LED/7W/12V/FL40/D/CRI95/30K	7	35	430	61	Warm White	3000K	25000	6/24	1.9	40°	DL, DIM, ES, EXF
C	Box	80503-SU	MR16/LED/7W/12V/FL35/D/CRI95/27K	7	50	450	64	Warm White	2700K	25000	6/24	1.97	35°	DL, DIM, ES, EXF
Medium Screw (E26) 120V														
D	Box	80142-SU	MR16/LED/7W/MED/D/27K	7	50	500	71	Warm White	2700K	25000	6/24	2.2	35°	DIM
	Box	80143-SU	MR16/LED/7W/MED/D/50K	7	50	500	71	Super White	5000K	25000	6/24	2.2	35°	DIM
2-Pin GU5.3 120V														
E	Box	80508-SU	MR16/LED/5W/GU5.3/120V/30K	5	50	450	90	Warm White	3000K	30000	6/24	2.04	38°	DL

DIM = Dimmable **ES** = Energy Star **DL** = Rated Damp Location **EXF** = Rated for Enclosed Fixture

Mini Reflector Lamps

Flood Light

- Twist & Lock (GU10)
- >80 CRI
- 120 Volts
- 220 Volts



PKG	Item#	Description	Watt	Eq.W	Lumen	LPW	Color	Kelvin	Hours	Carton	MOL (IN)	Beam Spread	Features
A	Box 80511-SU	PAR16/LED/7W/GU10/E/D/27K	7	75	500	71	Warm White	2700K	25000	6/24	2.2	35°	DIM, ES
	Box 80512-SU	PAR16/LED/7W/GU10/E/D/30K	7	75	500	71	Warm White	3000K	25000	6/24	2.2	35°	DIM, ES
B	Box 80516-SU	PAR16/LED/7W/GU10/D/40K	7	75	500	71	Cool White	4000K	25000	6/24	2.2	35°	DIM
	Box 80513-SU	PAR16/LED/7W/GU10/D/50K	7	75	500	71	Super White	5000K	25000	6/24	2.2	35°	DIM
	Box 80514-SU	PAR16/LED/7W/GU10/D/65K	7	75	500	71	Daylight	6500K	25000	6/24	2.2	35°	DIM
220 Volts													
C	Box 80306-SU	MR16/LED/6W/GU10/220V/40K	6	40	470	78	Cool White	4000K	20000	6/24	2.06	120°	

Mini Reflector Lamps Colored

Party & Decorative

- 75 CRI
- 12 Volts
- 120V

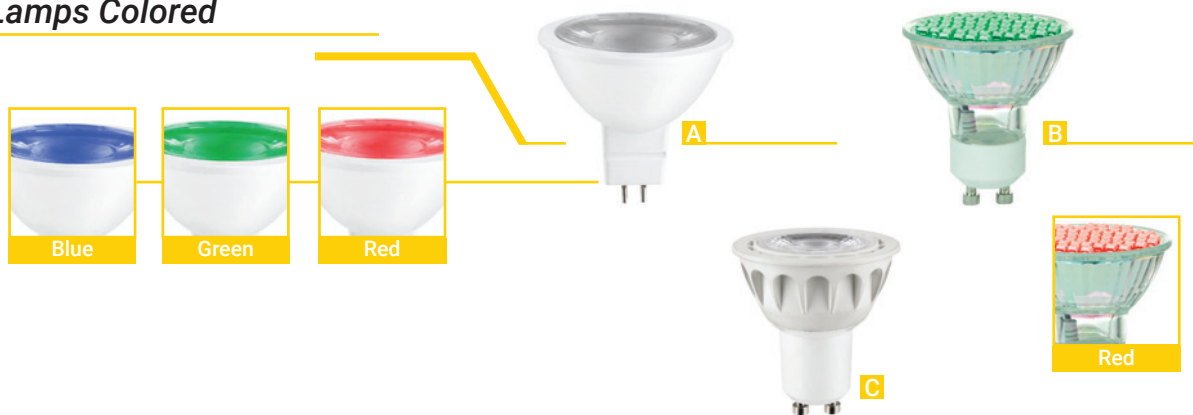

PKG	Item#	Description	Watt	Eq.W	Lumen	LPW	Color	Kelvin	Hours	Carton	MOL (IN)	Beam Spread	Features
2-Pin GU5.3 12V													
A	Box 80856-SU	MR16/LED/3W/GU5.3/12V/B	3	25	-	-	Blue	-	30000	6/24	1.96	30°	
	Box 80857-SU	MR16/LED/3W/GU5.3/12V/G	3	25	-	-	Green	-	30000	6/24	1.96	30°	
	Box 80855-SU	MR16/LED/3W/GU5.3/12V/R	3	25	-	-	Red	-	30000	6/24	1.96	30°	
Twist & Lock (GU10) 120V													
B	Box 80327-SU	MR16/LED/2.8W/GU10/G	2.8	20	-	-	Green	-	30000	12/120	2.2	-	
	Box 80328-SU	MR16/LED/2.8W/GU10/R	2.8	20	-	-	Red	-	30000	12/120	2.2	-	
C	Box 80520-SU	PAR16/LED/3W/GU10/B	3	25	-	-	Blue	-	15000	6	2.2	40°	

Reflector Lamps

Flood Light

- >80 CRI
- 120 Volts



PKG	Item#	Description	Watt	Eq.W	Lumen	LPW	Color	Kelvin	Hours	Carton	MOL (IN)	Beam Spread	Features	
R14 Intermediate Screw (E17)														
A	Box	80430-SU	R14/LED/N/E17/4W/D/E/27K	4	25	280	70	Warm White	2700k	25000	6/24	2.5	105°	DIM, ES
R14 Medium Screw (E26)														
B	Box	80431-SU	R14/LED/E26/4W/D/27K	4	25	250	63	Warm White	2700k	25000	6/24	2.16	105°	DIM
R20 Medium Screw (E26)														
C	Box	81130-SU	R20/LED/8W/D/E/27K	8	50	560	70	Warm White	2700K	25000	6/24	3.94	105°	DIM, ES
	Box	81131-SU	R20/LED/8W/D/E/30K	8	50	560	70	Warm White	3000K	25000	6/24	3.94	105°	DIM, ES
	Box	80677-SU	R20/LED/8W/D/40K	8	50	560	70	Cool White	4000K	25000	6/24	3.93	105°	DIM
	Box	80678-SU	R20/LED/8W/D/50K	8	50	560	70	Super White	5000K	25000	6/24	3.93	105°	DIM
BR30 Medium Screw (E26)														
D	Box	81136-SU	BR30/LED/10W/D/E/27K	10	65	750	75	Warm White	2700K	25000	6/24	5.31	105°	DL, DIM, ES
	Box	81137-SU	BR30/LED/10W/D/E/30K	10	65	750	75	Warm White	3000K	25000	6/24	5.31	105°	DL, DIM, ES
	Box	81150-SU	BR30/LED/10W/D/E/40K	10	65	750	75	Cool White	4000K	25000	6/24	5.31	105°	DL, DIM, ES
	Box	81156-SU	BR30/LED/10W/D/E/50K	10	65	750	75	Super White	5000K	25000	6/24	5.31	105°	DL, DIM, ES
	Box	81151-SU	BR30/LED/10W/D/65K	10	65	750	75	Daylight	6500K	25000	6/24	5.31	105°	DL, DIM
BR40 Medium Screw (E26)														
E	Box	88080-SU	BR40/LED/13W/D/ES/27K	13	75	950	73	Warm White	2700K	25000	6/24	6.41	105°	DL, DIM, ES
	Box	81159-SU	BR40/LED/14W/D/E/30K	14	85	1060	76	Warm White	3000K	25000	6/24	6.12	100°	DL, DIM, ES
	Box	81149-SU	BR40/LED/14W/D/E/40K	14	85	1060	76	Cool White	4000K	25000	6/24	6.81	100°	DL, DIM, ES
	Box	81154-SU	BR40/LED/14W/D/E/50K	14	85	1060	76	Super White	5000K	25000	6/24	6.12	110°	DL, DIM, ES
	Box	81135-SU	BR40/LED/14W/D/65K	14	85	1063	76	Daylight	6500K	25000	6/24	6.12	110°	DL, DIM
PAR16 Medium Screw (E26)														
F	Box	80124-SU	PAR16/LED/7W/D/E/27K	7	75	500	71	Warm White	2700K	25000	6/24	30.3	35°	DIM, ES
PAR20 Medium Screw (E26)														
G	Box	80018-SU	PAR20/LED/6W/FL35/D/E/27K	6	50	450	75	Warm White	2700K	25000	6/24	3.3	35°	DL, DIM, ES
	Box	80696-SU	PAR20/LED/6W/FL35/D/E/30K	6	50	450	75	Warm White	3000K	25000	6/24	3.3	35°	DL, DIM, ES
	Box	80697-SU	PAR20/LED/6W/FL35/D/E/40K	6	50	450	75	Cool White	4000K	25000	6/24	3.3	35°	DL, DIM, ES
	Box	80698-SU	PAR20/LED/6W/FL35/D/E/50K	6	50	450	75	Super White	5000K	25000	6/24	3.3	35°	DL, DIM, ES



PKG	Item#	Description	Watt	Eq.W	Lumen	LPW	Color	Kelvin	Hours	Carton	MOL (IN)	Beam Spread	Features
PAR30 Short Neck													
H	Box 80945-SU	PAR30/LED/10W/S/FL35/D/E/27K	10	75	750	75	Warm White	2700K	25000	6/24	3.33	35°	DIM, ES
	Box 80946-SU	PAR30/LED/10W/S/FL35/D/E/30K	10	75	750	75	Warm White	3000K	25000	6/24	3.33	35°	DIM, ES
	Box 80947-SU	PAR30/LED/10W/S/FL35/D/E/40K	10	75	750	75	Cool White	4000K	25000	6/24	3.33	35°	DIM, ES
	Box 80948-SU	PAR30/LED/10W/S/FL35/D/E/50K	10	75	750	75	Daylight	5000K	25000	6/24	3.33	35°	DIM, ES
PAR30 Short Neck 90 CRI													
I	Box 88048-SU	PAR30/LED/10W/FL40/D/90/27K	10	75	750	75	Warm White	2700K	40000	6/12	3.67	40°	DL, DIM
	Box 88049-SU	PAR30/LED/10W/FL40/D/90/30K	10	75	800	80	Warm White	3000K	40000	6/12	3.67	40°	WL, DIM
PAR30 Long Neck													
J	Box 80889-SU	PAR30LN/LED/10W/FL35/D/E/27K	10	75	750	75	Warm White	2700K	25000	6/24	4.4	35°	DIM, ES
	Box 80895-SU	PAR30LN/LED/10W/FL35/D/E/30K	10	75	750	75	Warm White	3000K	25000	6/24	4.4	35°	DIM, ES
	Box 80896-SU	PAR30LN/LED/10W/FL35/D/E/40K	10	75	750	75	Cool White	4000K	25000	6/24	4.4	35°	DIM, ES
	Box 80897-SU	PAR30LN/LED/10W/FL35/D/E/50K	10	75	750	75	Super White	5000K	25000	6/24	4.4	35°	DIM, ES
PAR30 Long Neck 90 CRI													
K	Box 89008-SU	PAR30LN/LED/10W/FL40/D/90/30K	10	75	800	80	Warm White	3000K	40000	6/12	4.57	40°	WL, DIM
PAR38													
L	Box 88063-SU	PAR38/LED/19W/FL40/D/27K	19	85	1000	53	Warm White	2700K	40000	6/12	4.72	40°	WL, DIM
	Box 88394-SU	PAR38/LED/18W/FL35/D/E/27K	18	120	1350	75	Warm White	2700K	25000	6/24	4.96	35°	DIM, ES
	Box 88395-SU	PAR38/LED/18W/FL35/D/E/30K	18	120	1350	75	Warm White	3000K	25000	6/24	4.96	35°	DIM, ES
	Box 88397-SU	PAR38/LED/18W/FL35/D/E/40K	18	120	1350	75	Cool White	4000K	25000	6/24	4.96	35°	DIM, ES
	Box 88396-SU	PAR38/LED/18W/FL35/D/E/50K	18	120	1350	75	Super White	5000K	25000	6/24	4.96	35°	DIM, ES
	Box 88398-SU	PAR38/LED/18W/FL35/D/65K	18	120	1350	75	Daylight	6500K	25000	6/24	4.96	35°	DL, DIM
PAR38 90 CRI Rated Wet Location													
M	Box 88082-SU	PAR38/LED/17W/FL40/D/90/27K	17	120	1150	68	Warm White	2700K	40000	6/12	5	40°	WL, DIM,
	Box 88083-SU	PAR38/LED/17W/FL40/D/90/30K	17	120	1200	71	Warm White	3000K	40000	6/12	5	40°	WL, DIM,



Reflector Lamps

AR111 Aluminum Reflector

- AR111
- Screw Terminal (G53)
- 80 CRI
- 12 Volts



PKG	Item#	Description	Watt	Eq.W	Lumen	LPW	Color	Kelvin	Hours	Carton	MOL (IN)	Beam Spread	Features
Box	81014-SU	AR111/LED/7W/30K/SP/12D	7	50	600	86	Warm White	3000K	30000	6/24	2.59	12°	Spot
Box	81013-SU	AR111/LED/7W/30K/NFL/24D	7	50	600	86	Warm White	3000K	30000	6/24	2.59	24°	Narrow
Box	81012-SU	AR111/LED/7W/30K/FL/36D	7	50	600	86	Warm White	3000K	30000	6/24	2.59	36°	Flood

Reflector Lamps Colored

Party & Decorative

- Medium Screw (E26)
- >80 CRI
- 120 Volts



PKG	Item#	Description	Watt	Eq.W	Lumen	LPW	Color	Kelvin	Hours	Carton	MOL (IN)	Beam Spread	Features
PAR16													
Box	80194-SU	JDR/LED/2.8W/W	2.8	25	240	86	White	6500K	30000	12/120	2.99	120°	
Box	80195-SU	JDR/LED/2.8W/B	2.8	25	-	-	Blue	-	30000	12/120	2.99	-	
Box	80197-SU	JDR/LED/2.8W/R	2.8	25	-	-	Red	-	30000	12/120	2.99	-	
Box	80198-SU	JDR/LED/2.8W/Y	2.8	25	-	-	Yellow	-	30000	12/120	2.99	-	

DIM = Dimmable

ES = Energy Star

DL = Rated Damp Location

WL = Rated Wet Location

WILD = Turtle Safe

Reflector Lamps Colored

Party & Decorative

- Medium Screw (E26)
- >80 CRI
- 120 Volts

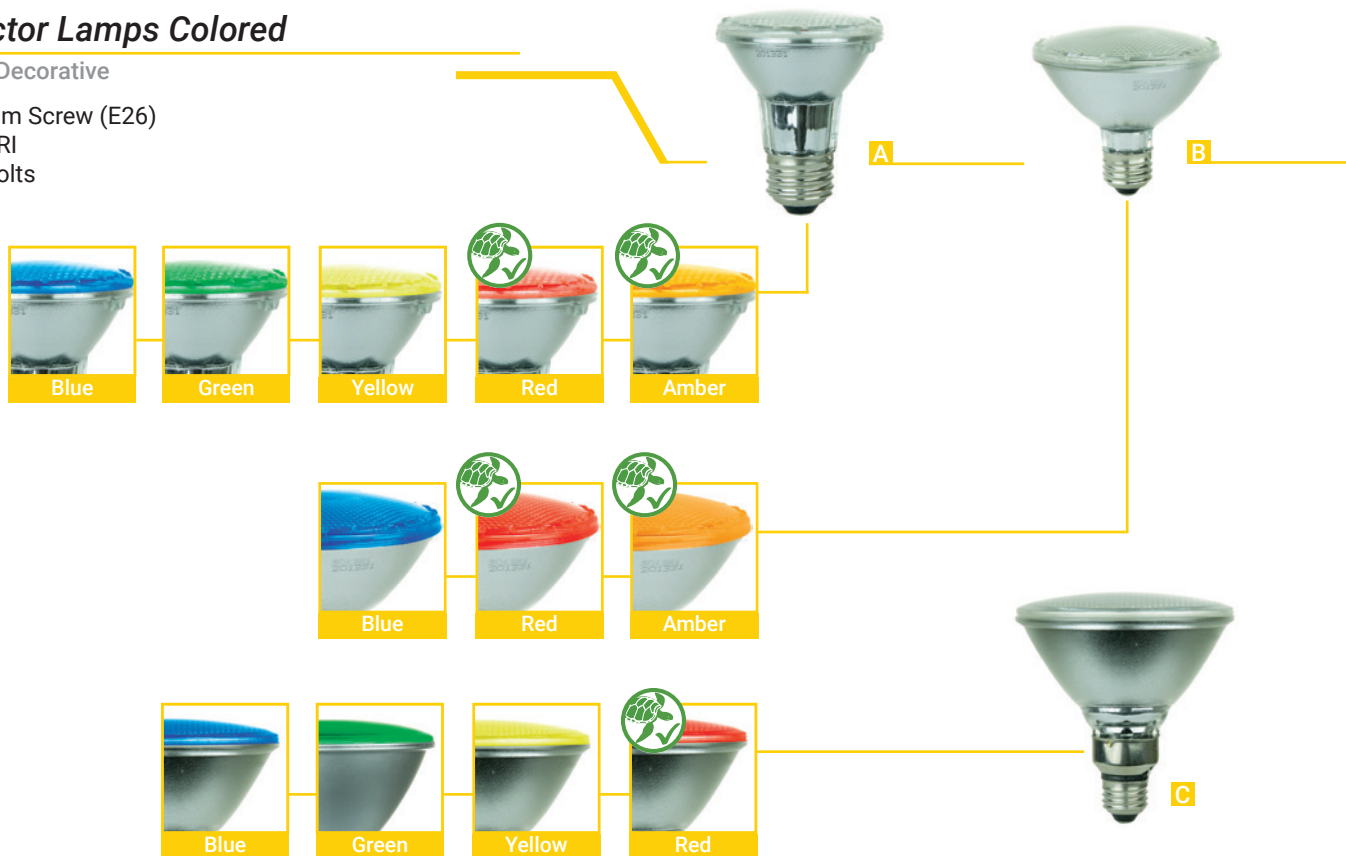

PKG	Item#	Description	Watt	Eq.W	Lumen	LPW	Color	Kelvin	Hours	Carton	MOL (IN)	Beam Spread	Features
PAR20													
A	Box 80001-SU	PAR20/LED/3W/B	3	-	-	-	Blue	-	30000	12/24	3.16	80°	
	Box 80002-SU	PAR20/LED/3W/G	3	-	-	-	Green	-	30000	12/24	3.16	30°	
	Box 80005-SU	PAR20/LED/2W/Y	3	-	-	-	Yellow	-	30000	12/24	3.16	80°	
	Box 80003-SU	PAR20/LED/2W/R	2	-	-	-	Red	-	30000	12/24	3.16	30°	WILD
	Box 80010-SU	PAR20/LED/2W/A	2	-	-	-	Amber	-	30000	12/24	3.16	30°	WILD
PAR30													
B	Box 80021-SU	PAR30/LED/4W/B	4	-	-	-	Blue	-	30000	12/24	3.55	60°	
	Box 80023-SU	PAR30/LED/3W/R	3	-	-	-	Red	-	30000	12/24	3.55	60°	WILD
	Box 80033-SU	PAR30/LED/3W/A	3	-	-	-	Amber	-	30000	12/24	3.55	30°	WILD
	Box 80043-SU	PAR38/LED/4W/R	4	-	-	-	Red	-	30000	6/12	5.25	30°	WILD
PAR38													
C	Box 80041-SU	PAR38/LED/6W/B	6	-	-	-	Blue	-	30000	6/12	5.25	30°	
	Box 80042-SU	PAR38/LED/6W/G	6	-	-	-	Green	-	30000	6/12	5.25	30°	
	Box 80045-SU	PAR38/LED/4W/Y	4	-	-	-	Yellow	-	30000	6/12	5.25	30°	
	Box 80043-SU	PAR38/LED/4W/R	4	-	-	-	Red	-	30000	6/12	5.25	30°	WILD

Indicator Lamps

- 80 CRI
- 120 Volts



PKG	Item#	Description	Watt	Eq.W	Lumen	LPW	Color	Kelvin	Hours	Carton	MOL (IN)	Features	
S6 Appliance Candelabra Screw (E12)													
A	Card	81065-SU	S6/LED/CL/1W/27K/E12/CD	1	10	50	50	Warm White	2700K	15000	6/24	1.85	DL
S11 Indicator Medium Screw (E26)													
B	Card	81069-SU	S11/LED/CL/1W/27K/E26/CD	1	10	50	50	Warm White	2700K	15000	6/24	2	DL
C	Card	81068-SU	S11/LED/FR/1W/27K/E26/CD	1	10	50	50	Warm White	2700K	15000	6/24	2	DL

Sign Lamps

Party & Decorative

- S14
- Medium Screw (E26)
- 120 Volts

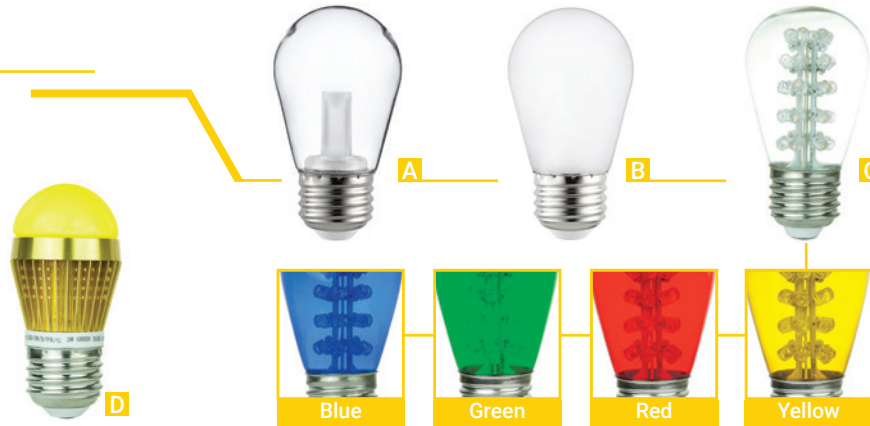

PKG	Item#	Description	Watt	Eq.W	Lumen	LPW	Color	Kelvin	Hours	Carton	MOL (IN)	Features	
A	Box	81067-SU	S14/LED/CL/1W/27K/E26	1	10	50	50	Warm White	2700K	15000	6/24	3.20	DL
B	Card	81066-SU	S14/LED/FR/1W/27K/E26/CD	1	10	50	50	Warm White	2700K	15000	6/24	3.20	DL
C	Box	80361-SU	S14/30LED/MED/C	1.7	10	106	62	Warm White	2900K	30000	20/200	3.20	
	Box	80362-SU	S14/30LED/MED/B	1.7	10	-	-	Blue	-	30000	20/200	3.20	
	Box	80363-SU	S14/30LED/MED/G	0.9	10	-	-	Green	-	30000	20/200	3.20	
	Box	80364-SU	S14/30LED/MED/R	1.1	10	-	-	Red	-	30000	20/200	3.20	
	Box	80365-SU	S14/30LED/MED/Y	1.1	10	-	-	Yellow	-	30000	20/200	3.20	
D	Box	80347-SU	S14/LED/3W/D/FR/Y	3	-	-	-	Yellow	-	40000	12/100	3.20	DIM

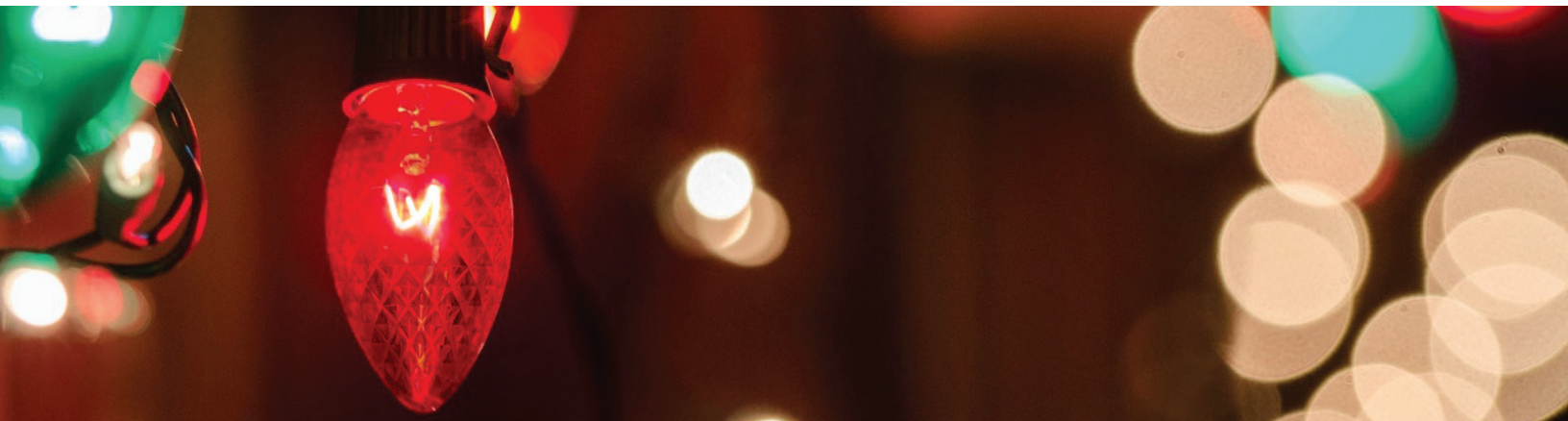

Night Lights

Holiday

- 120 Volts



A



B



Green

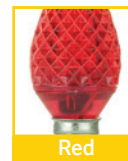

Red



Yellow



White

PKG	Item#	Description	Watt	Eq.W	Lumen	LPW	Color	Kelvin	Hours	Carton	MOL (IN)	Features
-----	-------	-------------	------	------	-------	-----	-------	--------	-------	--------	----------	----------

C7 | Candelabra Screw (E12)

A	Box	80700-SU	L3C7/LED/B/6PK	0.4	-	-	-	Blue	-	50000	20/80	2.25
	Box	80701-SU	L3C7/LED/G/6PK	0.4	-	-	-	Green	-	50000	20/80	2.25
	Box	80702-SU	L3C7/LED/R/6PK	0.4	-	-	-	Red	-	50000	20/80	2.25
	Box	80704-SU	L3C7/LED/Y/6PK	0.4	-	-	-	Yellow	-	50000	20/80	2.25
	Box	80703-SU	L3C7/LED/W/6PK	0.4	-	-	-	White	-	50000	20/80	2.25

C9 | Intermediate Screw (E17)

B	Box	80705-SU	L3C9/LED/B/6PK	0.4	-	-	-	Blue	-	50000	20/480	2.95
	Box	80706-SU	L3C9/LED/G/6PK	0.4	-	-	-	Green	-	50000	20/480	2.95
	Box	80707-SU	L3C9/LED/R/6PK	0.4	-	-	-	Red	-	50000	20/80	2.95
	Box	80709-SU	L3C9/LED/Y/6PK	0.4	-	-	-	Yellow	-	50000	20/480	2.95

Tubular

Miniature

- 80 CRI
- 120 Volts



A



B



C

PKG	Item#	Description	Watt	Eq.W	Lumen	LPW	Color	Kelvin	Hours	Carton	MOL (IN)	Features
-----	-------	-------------	------	------	-------	-----	-------	--------	-------	--------	----------	----------

T5 | Candelabra Screw (E12)

A	Card	81072-SU	T5/LED/CL/1W/27K/E12/CD	1	10	50	50	Warm White	2700K	15000	6/24	1.73	DL
---	------	----------	-------------------------	---	----	----	----	------------	-------	-------	------	------	----

T6 | Candelabra Screw (E12)

B	Card	81071-SU	T6/LED/CL/1W/27K/E12/CD	1	10	50	50	Warm White	2700K	15000	6/24	1.77	DL
---	------	----------	-------------------------	---	----	----	----	------------	-------	-------	------	------	----

T7 | Intermediate Screw (E17)

C	Card	81070-SU	T7/LED/CL/1W/27K/E17/CD	1	10	50	50	Warm White	2700K	15000	6/24	2.09	DL
---	------	----------	-------------------------	---	----	----	----	------------	-------	-------	------	------	----

Colored Tubular

Party & Decorative

- T10
- 120 Volts



A



B



Blue



Green



Red



Yellow

PKG	Item#	Description	Watt	Eq.W	Lumen	LPW	Color	Kelvin	Hours	Carton	MOL (IN)	Features
Medium Screw (E26)												
A	Box	80251-SU	T10/LED/1W/B	1	-	-	-	Blue	-	30000	10/100	2.41
	Box	80252-SU	T10/LED/1W/G	1	-	-	-	Green	-	30000	10/100	2.41
	Box	80253-SU	T10/LED/1W/R	1	-	-	-	Red	-	30000	10/100	2.41
	Box	80255-SU	T10/LED/1W/Y	1	-	-	-	Yellow	-	30000	10/100	2.41
Candelabra Screw (E12)												
B	Box	80256-SU	T10/LED/0.5W/C/B	0.5	-	-	-	Blue	-	30000	10/100	2.28
	Box	80268-SU	T10/LED/0.5W/C/G	0.5	-	-	-	Green	-	30000	10/100	2.28
	Box	80269-SU	T10/LED/0.5W/C/R	0.5	-	-	-	Red	-	30000	10/100	2.28
	Box	80272-SU	T10/LED/0.5W/C/Y	0.5	-	-	-	Yellow	-	30000	10/100	2.28



Elevator Bulb

1383 / GBF

- 80 CRI
- 12 Volts



A



B

PKG	Item#	Description	Watt	Eq.W	Lumen	LPW	Color	Kelvin	Hours	Carton	MOL (IN)	Beam Spread	Features
Single Contact Bayonet (BA15s)													
A	Box	80307-SU	1383/1LED/3W/SC/12V/WW	3	-	120	40	Warm White	3000K	30000	50	2.5	30°
Double Contact Bayonet (BA15d)													
B	Box	80375-SU	GBF/1LED/1.7W/DC/WW	1.7	-	95	56	Warm White	3000K	30000	50	1.77	30°

DIM = Dimmable ES = Energy Star DL = Rated Damp Location WL = Rated Wet Location



Halogen Alternative Specialty Lamps

- 80 CRI

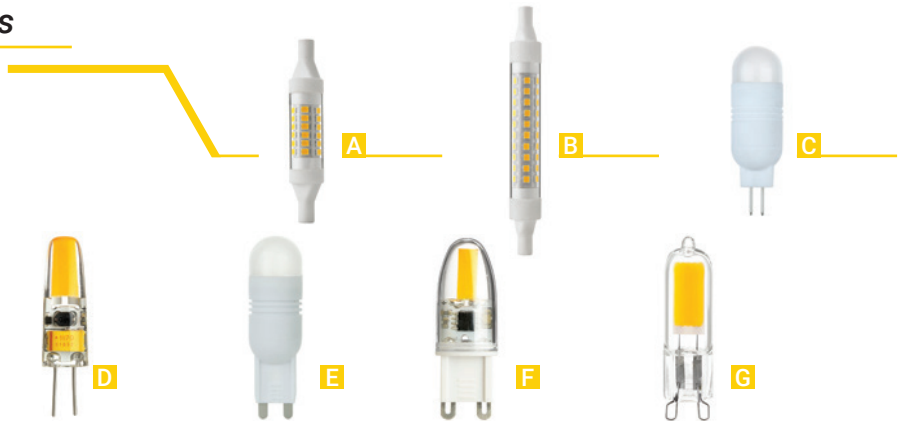

PKG	Item#	Description	Watt	Eq.W	Lumen	LPW	Color	Kelvin	Hours	Carton	MOL (IN)	Beam Spread	Features
Short Recessed Single Contact (R7s) 120V													
A	Card	81015-SU R7S/LED/4.5W/78MM/T5/30K/CD2	4.5	25	370	82	Warm White	3000K	10000	12	3.1	-	DL
	Card	81017-SU R7S/LED/4.5W/78MM/T8/30K/CD2	4.5	40	460	102	Warm White	3000K	10000	12	3.1	-	DL
Long Recessed Single Contact (R7s) 120V													
B	Card	81016-SU R7S/LED/7W/118MM/T5/30K/CD2	7	40	630	90	Warm White	3000K	10000	12	4.6	-	DL
	Card	81018-SU R7S/LED/8.5W/118MM/T8/30K/CD2	8.5	60	900	106	Warm White	3000K	10000	12	4.6	-	DL
G4 12V													
C	Card	80802-SU G4/LED/2.5W/12V/WW/CD	2.5	25	200	80	Warm White	3000K	30000	12/48	2.36	-	
	Card	80807-SU G4/LED/2.5W/12V/W/CD	2.5	25	220	88	White	6000K	30000	12/48	2.36	-	
D	Card	80861-SU G4/LED/1.5W/CL/12V/D/30K/CD	1.5	25	200	133	Warm White	3000K	25000	12/120	1.53	-	DL, DIM
G9 120V													
E	Box	80817-SU G9/LED/2.5W/WW	2.5	25	200	80	Warm White	3000K	30000	10/30	2.36	-	WL
F	Card	80865-SU G9/LED/1.6W/CL/120V/D/30K/CD	1.6	25	200	125	Warm White	3000K	25000	10/100	1.88	-	DL, DIM
G9 COB 120V													
G	Box	80811-SU G9/LED/2W/CL/120V/30K	2	25	200	100	Warm White	3000K	15000	12/120	1.97	-	DL
	Box	80813-SU G9/LED/3W/CL/120V/30K	3	35	400	133	Warm White	3000K	15000	12/120	2.28	-	DL
	Box	80812-SU G9/LED/2W/CL/120V/50K	2	25	200	100	Super White	5000K	15000	12/120	1.97	-	DL
	Box	80814-SU G9/LED/3W/CL/120V/50K	3	35	400	133	Super White	5000K	15000	12/120	2.28	-	DL

Hospitality Series

Warm Dimming

- Medium Screw (E26)
- 80 CRI
- 3000K-1700K Color Temperature
- 120 Volts

3000K 1700K
DIMMABLE



A



Smooth dimming from 3000K - 1700K turning the light to a light similar to that of warm candlelight glow



B



C

PKG	Item#	Description	Watt	Eq. W	Lumen	LPW	Color	Kelvin	Hours	Carton	MOL (IN)	Features	
A	Box	80500-SU	A19/LED/8W/DIM/WD/30-16K	8	50	700	88	Warm White	3000K-1700K	25000	12/48	4.25	DIM
B	Box	80505-SU	BR20/LED/8W/DIM/WD/30-16K	8	50	650	81	Warm White	3000K-1700K	25000	6/12	4.02	DIM
C	Box	80510-SU	BR30/LED/12W/DIM/WD/30-16K	12	65	1000	83	Warm White	3000K-1700K	25000	6/12	5.35	DIM

Plant Growth

- 120 Volts



A



B



Spectral Distribution

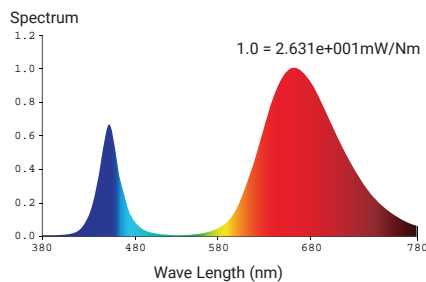

C

Cast the necessary light needed for indoor vegetation maintenance while keeping electrical costs as low as possible with Sunlite's LED plant grow lights.

PKG	Item#	Description	Watt	PPF umol/s	Color	Hours	Carton	MOL (IN)	Beam Spread	Features	
Medium Screw (E26)											
A	Box	88199-SU	PAR38/LED/PGL/16.5W	16.5	16.5	Plant	25000	6/24	5.03	40°	WL, DIM
B	Box	88197-SU	A19/LED/PGL/9W	9	11.318	Plant	15000	6/24	4.33	-	DL
Medium 2-Pin (G13)											
C	Box	88194-SU	T8/LED/PGL/4'/MV/18W/BYPASS	18	26.75	Plant	25000	10	47.67	-	DL

DIM = Dimmable

DL = Rated Damp Location

WL = Rated Wet Location

Decorative Lamps

Star Filament

- >75 CRI
- 120 Volts



PKG	Item#	Description	Watt	Eq.W	Lumen	LPW	Color	Kelvin	Hours	Carton	Finish	MOL (IN)	Features	
Candelabra Screw (E12)														
A	Box	80129-SU	CTC/LED/SF/1W/CL/23K	1	-	120	120	Warm White	2300K	20000	12/48	Clear	1.38	
Medium Screw (E26)														
B	Box	80127-SU	A19/LED/SF/1.8W/CL/23K	1.8	-	120	67	Warm White	2300K	20000	12/60	Clear	2.36	
C	Box	80128-SU	S19/LED/SF/1.8W/CL/23K	1.8	-	120	67	Warm White	2300K	20000	6/48	Clear	2.52	
Globe Medium Screw (E26)														
D	Box	80139-SU	G25/LED/SF/1.8W/CL/23K	1.8	-	120	67	Warm White	2300K	20000	6/48	Clear	3.15	
	Box	80153-SU	G30/LED/SF/1.8W/CL/23K	1.8	-	120	67	Warm White	2300K	20000	40	Clear	5.71	
	Box	80154-SU	G40/LED/SF/1.8W/CL/23K	1.8	-	120	67	Warm White	2300K	20000	24	Clear	4.92	
Tubular Medium Screw (E26)														
E	Box	80622-SU	T10/LED/SF/1.5W/CL/23K/128MM	1.5	20	100	67	Warm White	2300K	20000	24	Clear	5.04	
	Box	80624-SU	T10/LED/SF/2.4W/CL/23K/228MM	2.5	25	140	56	Warm White	2300K	20000	24	Clear	8.86	
	Box	80626-SU	T10/LED/SF/3W/CL/23K/300MM	3	30	190	63	Warm White	2300K	20000	24	Clear	11.81	



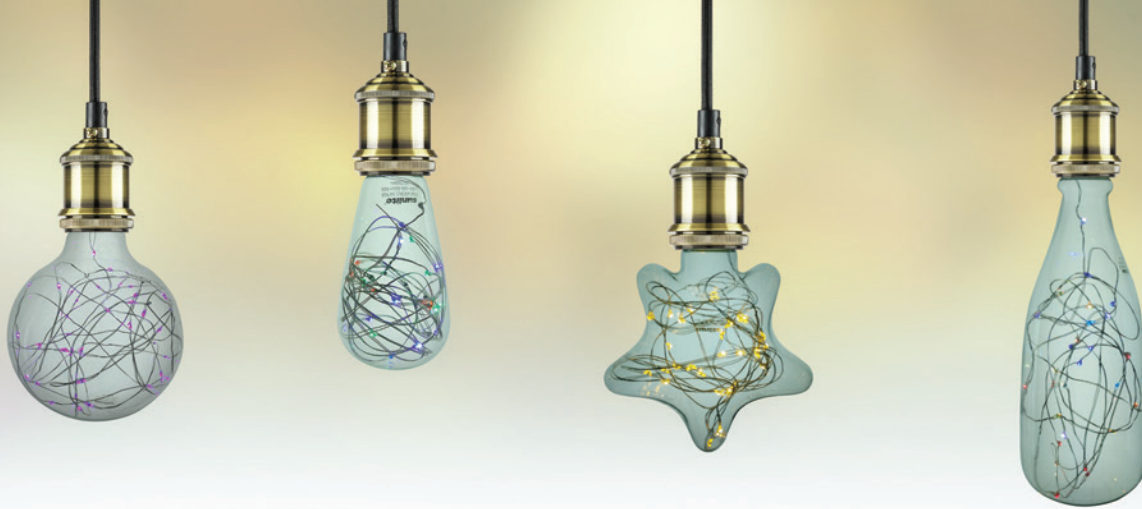

Decorative Lamps

Party & Decorative

- String Filament
- Medium Screw (E26)
- 100-260 Volts





PKG	Item#	Description	Watt	Eq.W	Lumen	LPW	Color	Kelvin	Hours	Carton	Finish	MOL (IN)	Features
G25													
A	Box	81174-SU	G25/LED/DX/1.5W/B	1.5	-	-	-	Blue	-	20000	6/24	Clear	4.2
	Box	81175-SU	G25/LED/DX/1.5W/G	1.5	-	-	-	Green	-	20000	6/24	Clear	4.2
	Box	81172-SU	G25/LED/DX/1.5W/R	1.5	-	-	-	Red	-	20000	6/24	Clear	4.2
	Box	81173-SU	G25/LED/DX/1.5W/P	1.5	-	-	-	Purple	-	20000	6/24	Clear	4.2
	Box	81177-SU	G25/LED/DX/1.5W/RGB	1.5	-	-	-	RGB	-	20000	6/24	Clear	4.2
	Box	81176-SU	G25/LED/DX/1.5W/27K	1.5	-	-	-	Warm White	2700K	20000	6/24	Clear	4.2
G30													
B	Box	81182-SU	G30/LED/DX/1.5W/27K	1.5	-	-	-	Warm White	2700K	20000	6/24	Clear	5.2
	Box	81180-SU	G30/LED/DX/1.5W/B	1.5	-	-	-	Blue	-	20000	6/24	Clear	5.2
	Box	81181-SU	G30/LED/DX/1.5W/G	1.5	-	-	-	Green	-	20000	6/24	Clear	5.2
	Box	81178-SU	G30/LED/DX/1.5W/R	1.5	-	-	-	Red	-	20000	6/24	Clear	5.2
	Box	81179-SU	G30/LED/DX/1.5W/P	1.5	-	-	-	Purple	-	20000	6/24	Clear	5.2
	Box	81183-SU	G30/LED/DX/1.5W/RGB	1.5	-	-	-	RGB	-	20000	6/24	Clear	5.2
G40													
C	Box	81186-SU	G40/LED/DX/1.5W/B	1.5	-	-	-	Blue	-	20000	6/24	Clear	6.8
	Box	81187-SU	G40/LED/DX/1.5W/G	1.5	-	-	-	Green	-	20000	6/24	Clear	6.8
	Box	81184-SU	G40/LED/DX/1.5W/R	1.5	-	-	-	Red	-	20000	6/24	Clear	6.8
	Box	81185-SU	G40/LED/DX/1.5W/P	1.5	-	-	-	Purple	-	20000	6/24	Clear	6.8
ST64													
D	Box	81190-SU	ST64/LED/DX/1.5W/B	1.5	-	-	-	Blue	-	20000	6/24	-	5.5
	Box	81191-SU	ST64/LED/DX/1.5W/G	1.5	-	-	-	Green	-	20000	6/24	-	5.5
	Box	81188-SU	ST64/LED/DX/1.5W/R	1.5	-	-	-	Red	-	20000	6/24	-	5.5
	Box	81189-SU	ST64/LED/DX/1.5W/P	1.5	-	-	-	Purple	-	20000	6/24	-	5.5
	Box	81193-SU	ST64/LED/DX/1.5W/RGB	1.5	-	-	-	RGB	-	20000	6/24	-	5.5
	Box	81192-SU	ST64/LED/DX/1.5W/27K	1.5	-	-	-	Warm White	2700K	20000	6/24	-	5.5
Specialty													
E	Box	81196-SU	DIAMOND/LED/DX/1.5/27K	1.5	-	-	-	Warm White	2700K	20000	6/24	-	-
F	Box	81197-SU	HEART/LED/DX/1.5W/RGB	1.5	-	-	-	RGB	-	20000	6/24	-	-
G	Box	81194-SU	STAR/LED/DX/1.5W/27K	1.5	-	-	-	Warm White	2700K	20000	6/24	-	-
H	Box	81195-SU	BOTTLE/LED/DX/1.5W/RGB	1.5	-	-	-	RGB	-	20000	6/24	-	-



Linestra Lamps

Vanity

- Linestra Base (S14s)
- 80 CRI
- 120 Volts



PKG	Item#	Description	Watt	Eq.W	Lumen	LPW	Color	Kelvin	Hours	Carton	MOL (IN)	Features
Box	53149-SU	LN/LED/5W/D/27K/120V	5	25	420	84	Warm White	2700K	30000	25	11.81	DIM
Box	53150-SU	LN/LED/8W/D/27K/120V	8	40	660	83	Warm White	2700K	30000	25	19.7	DIM
Box	53155-SU	LN/LED/16W/D/27K/120V	16	75	1300	81	Warm White	2700K	30000	12	39.4	DIM

Plug-In Lamps

- 4-Pin (2G11) Base
- >80 CRI
- 100-277 Volts



PKG	Item#	Description	Watt	Eq.W	Lumen	LPW	Color	Kelvin	Hours	Carton	MOL (IN)	Features
Bypass FT												
Box	81055-SU	FT/LED/BP/23W/30K	23	55	2600	115	Warm White	3000K	50000	10/40	22.16	DL, EXF
Box	81056-SU	FT/LED/BP/23W/40K	23	55	2800	122	Cool White	4000K	50000	10/40	22.16	DL, EXF
Plug and Play FT												
Box	81057-SU	FT/LED/IS/23W/30K	23	40	2600	115	Warm White	3000K	50000	10/40	22.16	DL, EXF
Box	81058-SU	FT/LED/IS/23W/35K	23	40	2600	115	Neutral White	3500K	50000	10/40	22.16	DL, EXF
Box	81059-SU	FT/LED/IS/23W/40K	23	40	2800	122	Cool White	4000K	50000	10/40	22.16	DL, EXF
Box	81060-SU	FT/LED/IS/23W/50K	23	40	2800	122	Super White	5000K	50000	10/40	22.16	DL, EXF

DIM = Dimmable **DL** = Rated Damp Location **DLC** = DLC Approved **EXF** = Rated for Enclosed Fixture

Plug-In Lamps

- >80 CRI
- 100-277 Volts

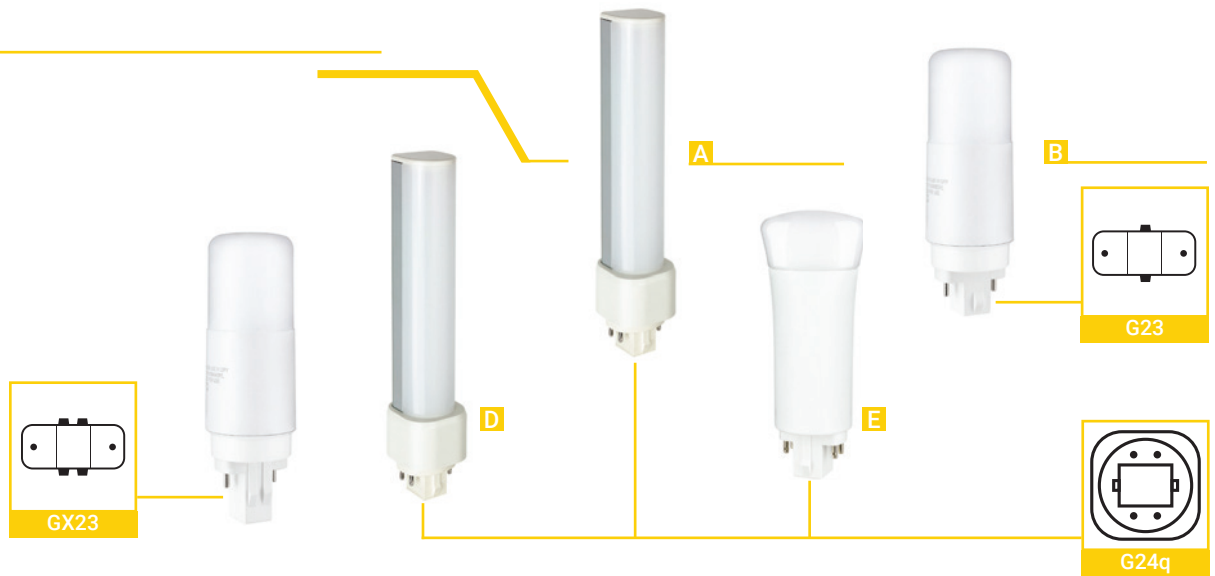

PKG	Item#	Description	Watt	Eq.W	Lumen	LPW	Color	Kelvin	Hours	Carton	MOL (IN)	Features	
Bypass PLD 4-Pin LED Base (G24q)													
A	Box	88284-SU	PLD/LED/BP/7W/30K	7	13	700	100	Warm White	3000K	50000	12/48	5.82	DL, EXF
	Box	88292-SU	PLD/LED/BP/9.5W/30K	9.5	18	900	95	Warm White	3000K	50000	12/48	6.61	DL, EXF
	Box	88296-SU	PLD/LED/BP/9.5W/40K	9.5	18	900	95	Cool White	4000K	50000	12/48	6.61	DL, EXF
	Box	88298-SU	PLD/LED/BP/9.5W/50K	9.5	18	900	95	Super White	5000K	50000	12/48	6.65	DL, EXF
Bypass Vertical 2-Pin (G23)													
B	Box	85425-SU	PLV/LED/BP/7W/G23/30K	7	13	700	100	Warm White	3000K	50000	12/48	4.52	DL, EXF
	Box	85426-SU	PLV/LED/BP/7W/G23/40K	7	13	700	100	Cool White	4000K	50000	12/48	4.52	DL, EXF
Bypass Vertical 2-Pin (GX23)													
C	Box	85430-SU	PLV/LED/BP/7W/GX23/30K	7	13	700	100	Warm White	3000K	50000	12/48	4.78	DL, EXF
	Box	85431-SU	PLV/LED/BP/7W/GX23/40K	7	13	700	100	Cool White	4000K	50000	12/48	4.78	DL, EXF
Plug and Play PLD 4-Pin LED Base (G24q)													
D	Box	88271-SU	PLD/LED/IS/9W/30K	9	18	950	106	Warm White	3000K	50000	12/48	6.65	DL, DLC, EXF
	Box	88269-SU	PLD/LED/IS/9W/35K	9	18	950	106	Neutral White	3500K	50000	12/48	6.65	DL, DLC, EXF
	Box	88273-SU	PLD/LED/IS/9W/40K	9	18	1000	111	Cool White	4000K	50000	12/48	6.65	DL, DLC, EXF
	Box	88275-SU	PLD/LED/IS/9W/50K	9	18	1000	111	Super White	5000K	50000	12/48	6.57	DL, DLC, EXF
Plug and Play Vertical 4-Pin LED Base (G24q)													
E	Box	88214-SU	PLV/LED/IS/9W/35K	9	18	950	106	Neutral White	3500K	50000	12/48	4.56	DL, DLC, EXF
	Box	88213-SU	PLV/LED/IS/9W/40K	9	18	1000	111	Cool White	4000K	50000	12/48	4.56	DL, DLC, EXF

Bypass Installation

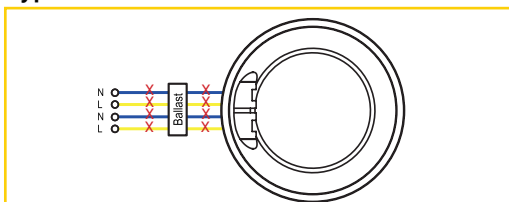

Step 1
Cut off the wires and remove the ballast

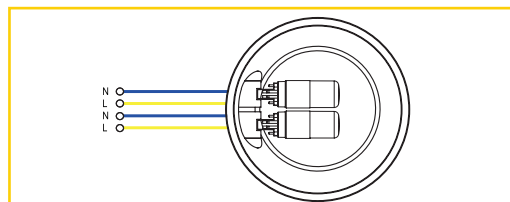

Step 2
Reconnect the wires and plug in the lamps

T5 Advanced Bypass Dual End

Linear Tube Lamp

- T5
- Miniature Bi-Pin (G5)
- >80 CRI
- 120-277 Volts



Instant Start

No Ballast Required

High Lumen Per Watt

Eco-Friendly No Mercury

PKG	Item#	Description	Watt	Eq.W	Lumen	LPW	Color	Kelvin	Hours	Carton	MOL (IN)	Features
2 Foot												
Sleeve	87985-SU	T5/LED/BPD/2'/12W/30K	12	T5	1400	117	Warm White	3000K	50000	10	23.22	DL, EXF
Sleeve	87986-SU	T5/LED/BPD/2'/12W/40K	12	T5	1400	117	Cool White	4000K	50000	10	23.22	DL, EXF
Sleeve	87987-SU	T5/LED/BPD/2'/12W/50K	12	T5	1500	125	Super White	5000K	50000	10	23.22	DL, EXF
3 Foot												
Sleeve	87990-SU	T5/LED/BPD/3'/16W/30K	16	T5	1800	113	Warm White	3000K	50000	10	35.7	DL, EXF
Sleeve	87991-SU	T5/LED/BPD/3'/16W/40K	16	T5	1800	113	Cool White	4000K	50000	10	35.7	DL, EXF
Sleeve	87992-SU	T5/LED/BPD/3'/16W/50K	16	T5	1900	119	Super White	5000K	50000	10	35.7	DL, EXF
4 Foot												
Sleeve	88486-SU	T5/LED/BPD/4'/13W/35K	13	T5	1600	123	Neutral White	3500K	50000	25	45.8	DL, DLC, EXF
Sleeve	88487-SU	T5/LED/BPD/4'/13W/40K	13	T5	1650	127	Cool White	4000K	50000	25	45.8	DL, DLC, EXF
Sleeve	88488-SU	T5/LED/BPD/4'/13W/50K	13	T5	1700	131	Super White	5000K	50000	25	45.8	DL, DLC, EXF
4 Foot High Lumens												
Sleeve	88415-SU	T5/LED/BPD/4'/25W/30K	25	T5	3300	132	Warm White	3000K	50000	10	45.8	DL, DLC, EXF
Sleeve	88416-SU	T5/LED/BPD/4'/12W/35K	25	T5	3300	132	Neutral White	3500K	50000	10	45.8	DL, DLC, EXF
Sleeve	88417-SU	T5/LED/BPD/4'/25W/40K	25	T5	3500	140	Cool White	4000K	50000	10	45.8	DL, DLC, EXF
Sleeve	88418-SU	T5/LED/BPD/4'/25W/50K	25	T5	3500	140	Super White	5000K	50000	10	45.8	DL, DLC, EXF

Advanced Dual End Bypass Installation

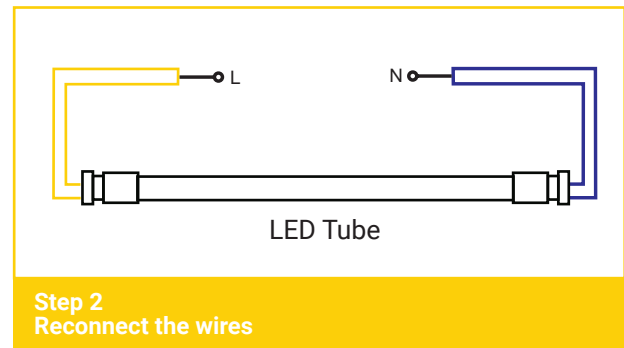
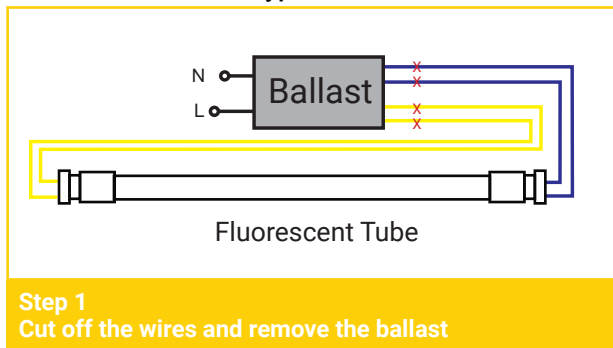

*Dual-end powered LED tube lamp has live and neutral pins on the opposite side. When you wire a dual-ended tube, you will need to connect neutral wires to one end and live wires to the other end.

T8 Advanced Bypass Dual End

Linear Tube Lamp

- T8
- 82 CRI
- 120-277 Volts



PKG	Item#	Description	Watt	Eq.W	Lumen	LPW	Color	Kelvin	Hours	Carton	MOL (IN)	Features
-----	-------	-------------	------	------	-------	-----	-------	--------	-------	--------	----------	----------

2 Foot

A	Sleeve	88430-SU	T8/LED/BPD/2'/9W/30K	9	T8 & T12	1100	122	Warm White	3000K	50000	10	23.22	DL, DLC, EXF
	Sleeve	88427-SU	T8/LED/BPD/2'/9W/35K	9	T8 & T12	1100	122	Neutral White	3500K	50000	10	23.22	DL, DLC, EXF
	Sleeve	88431-SU	T8/LED/BPD/2'/9W/40K	9	T8 & T12	1150	128	Cool White	4000K	50000	10	23.22	DL, DLC, EXF
	Sleeve	88432-SU	T8/LED/BPD/2'/9W/50K	9	T8 & T12	1150	128	Super White	5000K	50000	10	23.22	DL, DLC, EXF
	Sleeve	88429-SU	T8/LED/BPD/2'/9W/65K	9	T8 & T12	1150	128	Daylight	6500K	50000	10	23.22	DL, EXF

3 Foot

	Sleeve	88445-SU	T8/LED/BPD/3'/12W/30K	12	T8 & T12	1400	117	Warm White	3000K	50000	10	35.7	DL, DLC, EXF
	Sleeve	88446-SU	T8/LED/BPD/3'/12W/40K	12	T8 & T12	1450	121	Cool White	4000K	50000	10	35.7	DL, DLC, EXF
	Sleeve	88447-SU	T8/LED/BPD/3'/12W/50K	12	T8 & T12	1450	121	Super White	5000K	50000	10	35.7	DL, DLC, EXF
	Sleeve	88448-SU	T8/LED/BPD/3'/12W/65K	12	T8 & T12	1450	121	Daylight	6500K	50000	10	35.7	DL, EXF

4 Foot

	Sleeve	88433-SU	T8/LED/BPD/4'/14W/30K	14	T8 & T12	1700	121	Warm White	3000K	50000	10	47.67	DL, DLC, EXF
	Sleeve	88425-SU	T8/LED/BPD/4'/14W/40K/EM	14	T8 & T12	1800	129	Cool White	4000K	50000	10	47.67	DL, DLC, EM
	Sleeve	88435-SU	T8/LED/BPD/4'/14W/50K	14	T8 & T12	1800	129	Super White	5000K	50000	10	47.67	DL, DLC, EXF
	Sleeve	88449-SU	T8/LED/BPD/4'/14W/65K	14	T8 & T12	1800	129	Daylight	6500K	50000	10	47.67	DL, EXF

4 Foot | High Lumens

	Sleeve	88424-SU	T8/LED/BPD/4'/17W/30K/EM	17	T8 & T12	2200	129	Warm White	3000K	50000	10	47.67	DL, DLC, EM
	Sleeve	88428-SU	T8/LED/BPD/4'/17W/35K	17	T8 & T12	2100	124	Neutral White	3500K	50000	10	47.67	DL, DLC, EXF
	Sleeve	88437-SU	T8/LED/BPD/4'/17W/40K	17	T8 & T12	2200	129	Cool White	4000K	50000	10	47.67	DL, DLC, EXF
	Sleeve	88438-SU	T8/LED/BPD/4'/17W/50K	17	T8 & T12	2200	129	Super White	5000K	50000	10	47.67	DL, DLC, EXF
	Sleeve	88439-SU	T8/LED/BPD/4'/17W/65K	17	T8 & T12	2200	129	Daylight	6500K	50000	10	47.67	DL

8 Foot | Recessed Double Contact (R17d)

B	Sleeve	88452-SU	T8/LED/BPD/8'/43W/40K/HO	43	T8 & T12	5500	128	Cool White	4000K	50000	10	94	DL, EXF
----------	--------	----------	--------------------------	----	----------	------	-----	------------	-------	-------	----	----	---------

8 Foot | Double Ended (Fa8)

C	Sleeve	88440-SU	T8/LED/BPD/8'/43W/30K	43	T8 & T12	5000	116	Warm White	3000K	50000	10	94	DL, DLC, EXF
	Sleeve	88441-SU	T8/LED/BPD/8'/43W/40K	43	T8 & T12	5500	128	Cool White	4000K	50000	10	94	DL, DLC, EXF
	Sleeve	88442-SU	T8/LED/BPD/8'/43W/50K	43	T8 & T12	5500	128	Super White	5000K	50000	10	94	DL, DLC, EXF
	Sleeve	88443-SU	T8/LED/BPD/8'/43W/65K	43	T8 & T12	5500	128	Daylight	6500K	50000	10	94	DL, EXF

T8 Bypass Single End

Linear Tube Lamp

- T8
- Medium 2-Pin (G13)
- 82 CRI
- 120-277 Volts



PKG	Item#	Description	Watt	Eq.W	Lumen	LPW	Color	Kelvin	Hours	Carton	MOL (IN)	Features
2 Foot												
Sleeve	88035-SU	T8/LED/BPS/2'/9W/50K	9	T8 & T12	1150	128	Super White	5000K	50000	10	23.22	DL, DLC, EXF
4 Foot												
Sleeve	88162-SU	T8/LED/BPS/4'/15W/30K	15	T8 & T12	1700	113	Warm White	3000K	50,000	10	47.67	DL, DLC, EXF
Sleeve	88163-SU	T8/LED/BPS/4'/15W/40K	15	T8 & T12	1800	120	Cool White	4000K	50000	10	47.67	DL, DLC, EXF
Sleeve	88164-SU	T8/LED/BPS/4'/15W/50K	15	T8 & T12	1800	120	Super White	5000K	50000	10	47.67	DL, DLC, EXF
4 Foot High Lumens												
Sleeve	88172-SU	T8/LED/BPS/4'/18W/30K	18	T8 & T12	2100	117	Warm White	3000K	50000	10	47.67	DL, DLC, EXF
Sleeve	88173-SU	T8/LED/BPS/4'/18W/40K	18	T8 & T12	2200	122	Cool White	4000K	50000	10	47.67	DL, DLC, EXF
Sleeve	88174-SU	T8/LED/BPS/4'/18W/50K	18	T8 & T12	2200	122	Super White	5000K	50000	10	47.67	DL, DLC, EXF

T8 U-Bend Bypass Single End

Linear Tube Lamp

- T8
- 2x Medium 2-Pin (2G13)
- 82 CRI
- 120-277 Volts



PKG	Item#	Description	Watt	Eq.W	Lumen	LPW	Color	Kelvin	Hours	Carton	MOL (IN)	Features
Box	87907-SU	T8/LED/BPS/U/18W/30K	18	T8 U & T12 U	2100	117	Warm White	3000K	50000	6	-	DL, EXF
Box	87908-SU	T8/LED/BPS/U/18W/40K	18	T8 U & T12 U	2200	122	Cool White	4000K	50000	6	-	DL, EXF

Single End Bypass Installation

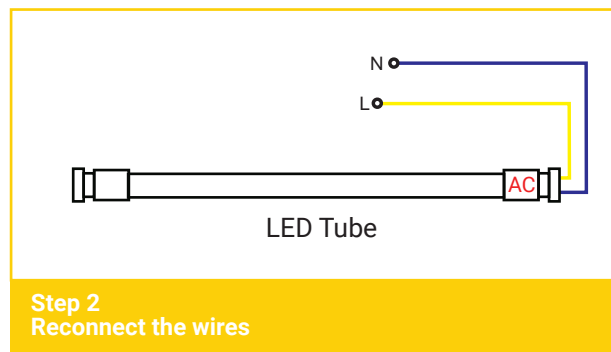
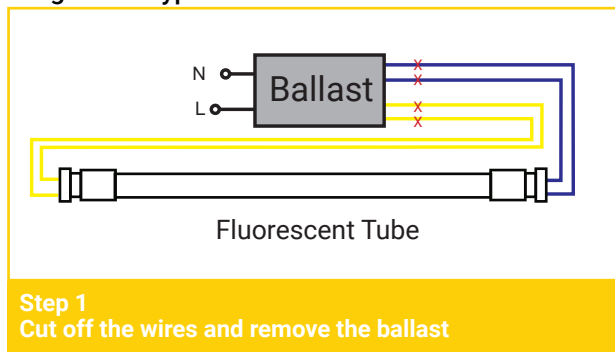

*Single-ended powered LED lamp has the live and neutral pins on the same side of the lamp.



T5 Plug and Play

Linear Tube Lamp

- T5
- Miniature Bi-Pin (G5)
- >80 CRI
- 120-277 Volts



Plug & Play



Check website for ballast compatibility list

PKG	Item#	Description	Watt	Eq.W	Lumen	LPW	Color	Kelvin	Hours	Carton	MOL (IN)	Features
2 Foot												
Sleeve	88220-SU	T5/LED/IS/2'/11W/30K	11	T5	1350	123	Warm White	3000K	50000	10	23.22	DL, EXF
Sleeve	88221-SU	T5/LED/IS/2'/11W/40K	11	T5	1400	127	Cool White	4000K	50000	10	23.22	DL, EXF
Sleeve	88222-SU	T5/LED/IS/2'/11W/50K	11	T5	1400	127	Super White	5000K	50000	10	23.22	DL, EXF
3 Foot												
Sleeve	87980-SU	T5/LED/IS/3'/18W/30K	18	T5	2100	117	Warm White	3000K	50000	10	35.7	DL, EXF
Sleeve	87981-SU	T5/LED/IS/3'/18W/40K	18	T5	2100	117	Cool White	4000K	50000	10	35.7	DL, EXF
Sleeve	87982-SU	T5/LED/IS/3'/18W/50K	18	T5	2200	122	Super White	5000K	50000	10	35.7	DL, EXF
4 Foot												
Sleeve	88420-SU	T5/LED/IS/4'/25W/30K	25	T5	3300	132	Warm White	3000K	50000	10	45.8	DL, DLC, EXF
Sleeve	88225-SU	T5/LED/IS/4'/25W/35K	25	T5	3300	132	Neutral White	3500K	50000	10	45.8	DL, EXF
Sleeve	88421-SU	T5/LED/IS/4'/25W/40K	25	T5	3500	140	Cool White	4000K	50000	10	45.8	DL, DLC, EXF
Sleeve	88230-SU	T5/LED/IS/4'/25W/50K	25	T5	3200	128	Super White	5000K	50000	10	45.8	DL, DLC, EXF
Sleeve	88423-SU	T5/LED/IS/4'/25W/65K	25	T5	3500	140	Daylight	6500K	50000	10	45.8	DL, EXF

T8 Plug and Play

Linear Tube Lamp

- T8
- Medium 2-Pin (G13)
- 82 CRI
- 120-277 Volts



Plug & Play



Check website for ballast compatibility list

PKG	Item#	Description	Watt	Eq.W	Lumen	LPW	Color	Kelvin	Hours	Carton	MOL (IN)	Features	
2 Foot													
A	Sleeve	88400-SU	T8/LED/IS/2'/8W/30K	8	T8	1200	150	Warm White	3000K	50000	10	23.22	DL, DLC, EXF
	Sleeve	88399-SU	T8/LED/IS/2'/8W/35K	8	T8	1200	150	Neutral White	3500K	50000	10	23.22	DL, DLC, EXF
	Sleeve	88401-SU	T8/LED/IS/2'/8W/40K	8	T8	1250	156	Cool White	4000K	50000	10	23.22	DL, DLC, EXF
	Sleeve	88402-SU	T8/LED/IS/2'/8W/50K	8	T8	1250	156	Super White	5000K	50000	10	23.22	DL, DLC, EXF
	Sleeve	88079-SU	T8/LED/IS/2'/9W/60K	9	T8	1150	128	Daylight	6000K	50000	10	23.22	DL, EXF
	Sleeve	88403-SU	T8/LED/IS/2'/8W/65K	8	T8	1250	156	Daylight	6500K	50000	10	23.22	DL, EXF
3 Foot													
	Sleeve	87960-SU	T8/LED/IS/3'/11W/30K	11	T8	1450	132	Warm White	3000K	50000	10	35.7	DL, EXF
	Sleeve	87971-SU	T8/LED/IS/3'/11W/40K	11	T8	1450	132	Cool White	4000K	50000	10	35.7	DL, EXF
	Sleeve	87964-SU	T8/LED/IS/3'/11W/50K	11	T8	1450	132	Super White	5000K	50000	10	35.7	DL, EXF
	Sleeve	87963-SU	T8/LED/IS/3'/11W/65K	11	T8	1450	132	Daylight	6500K	50000	10	35.7	DL, EXF
4 Foot													
	Sleeve	88090-SU	T8/LED/IS/4'/12W/30K	12	T8	1800	150	Warm White	3000K	50000	10	47.67	DL, EXF
	Sleeve	88404-SU	T8/LED/IS/4'/11.5W/30K	11.5	T8	1700	148	Warm White	3000K	50000	10	47.67	DL, DLC, EXF
	Sleeve	88412-SU	T8/LED/IS/4'/11.5W/35K	11.5	T8	1700	148	Neutral White	3500K	50000	10	47.67	DL, DLC, EXF
	Sleeve	88405-SU	T8/LED/IS/4'/11.5W/40K	11.5	T8	1800	124	Cool White	4000K	50000	10	47.67	DL, DLC, EXF
	Sleeve	88406-SU	T8/LED/IS/4'/11.5W/50K	11.5	T8	1800	157	Super White	5000K	50000	10	47.67	DL, DLC, EXF
	Sleeve	88407-SU	T8/LED/IS/4'/11.5W/65K	11.5	T8	1800	157	Daylight	6500K	50000	10	47.67	DL, EXF
4 Foot Shatter Proof													
	Sleeve	88181-SU	T8/LED/IS/4'/14W/30K/SP	14	T8	1800	129	Warm White	3000K	50000	10	47.67	DL, DLC, EXF
	Sleeve	88183-SU	T8/LED/IS/4'/14W/40K/SP	14	T8	1800	129	Cool White	4000K	50000	10	47.67	DL, DLC, EXF
	Sleeve	88074-SU	T8/LED/IS/4'/14W/50K	14	T8	1800	129	Super White	5000K	50000	10	47.67	DL, EXF
4 Foot High Lumens													
	Sleeve	88408-SU	T8/LED/IS/4'/15W/30K	15	T8	2100	140	Warm White	3000K	50000	10	47.67	DL, DLC, EXF
	Sleeve	88413-SU	T8/LED/IS/4'/15W/35K	15	T8	2100	140	Neutral White	3500K	50000	10	47.67	DL, DLC, EXF
	Sleeve	88409-SU	T8/LED/IS/4'/15W/40K	15	T8	2200	147	Cool White	4000K	50000	10	47.67	DL, DLC, EXF
	Sleeve	88410-SU	T8/LED/IS/4'/15W/50K	15	T8	2200	147	Super White	5000K	50000	10	47.67	DL, DLC, EXF
8 Foot Single Pin (Double Ended)													
B	Sleeve	88240-SU	T8/LED/IS/8'/33W/40K	33	T8	4400	133	Cool White	4000K	50000	10	93.7	DL, EXF
	Sleeve	88241-SU	T8/LED/IS/8'/33W/65K	33	T8	4400	133	Daylight	6500K	50000	10	93.7	DL, EXF

DL = Rated Damp Location DLC = DLC Approved EXF = Rated for Enclosed Fixture

T8 Plug and Play

Linear Tube Lamp

- T8
- 82 CRI
- 120-277 Volts



Check website for ballast compatibility list

PKG	Item#	Description	Watt	Eq.W	Lumen	LPW	Color	Kelvin	Hours	Carton	MOL (IN)	Features
8Foot Recessed Double Contact (R17d)												
Sleeve	88245-SU	T8/LED/8'/42W/IS/HO	42	T8	5500	131	Cool White	4000K	50000	10	93.7	DL, EXF

T8 Plug and Play / Economy Type

Linear Tube Lamp

- T8
- Medium 2-Pin (G13)
- 82 CRI
- 120-277 Volts



Check website for ballast compatibility list

* Economy type not compatible with emergency backup battery. Compatible with Instant start and some program start ballast.

PKG	Item#	Description	Watt	Eq.W	Lumen	LPW	Color	Kelvin	Hours	Carton	MOL (IN)	Features
4 Foot												
Sleeve	88454-SU	T8/LED/IS/4'/12W/35K/PPS	12	T8	1700	142	Neutral White	3500K	50000	10	47.67	DL, DLC, EXF
Sleeve	88455-SU	T8/LED/IS/4'/12W/40K/PPS	12	T8	1800	150	Cool White	4000K	50000	10	47.67	DL, DLC, EXF
Sleeve	88456-SU	T8/LED/IS/4'/12W/50K/PPS	12	T8	1800	150	Super White	5000K	50000	10	47.67	DL, DLC, EXF

4 Foot | High Lumens

Sleeve	88459-SU	T8/LED/IS/4'/15W/35K/PPS	15	T8	2100	140	Neutral White	3500K	50000	10	47.67	DL, DLC, EXF
Sleeve	88460-SU	T8/LED/IS/4'/15W/40K/PPS	15	T8	2200	147	Cool White	4000K	50000	10	47.67	DL, DLC, EXF
Sleeve	88461-SU	T8/LED/IS/4'/15W/50K/PPS	15	T8	2200	147	Super White	5000K	50000	10	47.67	DL, DLC, EXF
Sleeve	88462-SU	T8/LED/IS/4'/15W/65K/PPS	15	T8	2200	147	Daylight	6500K	50000	10	47.67	DL, EXF

T8 U-Bend Plug and Play

Linear Tube Lamp

- T8
- 2x Medium 2-Pin (2G13)
- 82 CRI
- 120-277 Volts



Check website for ballast compatibility list

PKG	Item#	Description	Watt	Eq.W	Lumen	LPW	Color	Kelvin	Hours	Carton	MOL (IN)	Features
High Lumens												
Box	87906-SU	T8/LED/IS/U/17W/40K	17	T8 U	2200	129	Cool White	4000K	50,000	6	22.44	DL, EXF
Box	87910-SU	T8/LED/IS/U/11.5W/40K	11.5	T8 U	1800	157	Cool White	4000K	50000	6	22.44	DLC, EXF
Box	87911-SU	T8/LED/IS/U/15W/40K	15	T8 U	2200	147	Cool White	4000K	50000	6	22.44	DLC, EXF

High Lumen Lamps

Corn Cob

- >80 CRI
- 100-277 Volts
- Recommended Use Without Ballast



150 Watt Traditional HID

36 Watt LED Corn Bulb



A



B



C



D

Amber



E

Mogul Base



Adapter

Med E26 Base to E39 Mogul Base Adapter

Direct Line Voltage

IP64

HID Replacement Lamps

Suitable For Enclosed Fixtures

PKG	Item#	Description	Watt	Eq.W	Lumen	LPW	Color	Kelvin	Hours	Carton	MOL (IN)	Features	
Medium Screw (E26)													
A	Box	81003-SU	TUL/LED/24W/E26/MV/50K	24	175	3200	133	Super White	5000K	50000	20	8.9	DL, DLC
	Box	81004-SU	TUL/LED/32W/E26/MV/50K	32	200	4200	131	Super White	5000K	50000	20	10.39	DL, DLC
B	Box	80850-SU	CC/LED/15W/E26/MV/50K	15	100	1950	130	Super White	5000K	50000	12	6.73	DL, EXF
Medium Screw (E26) E39 Adapter Included													
C	Box	81301-SU	CC/LED/18W/E26-E39/MV/50K	18	125	2250	125	Super White	5000K	50000	12	5.7	DL, DLC, EXF
	Box	81302-SU	CC/LED/27W/E26-E39/MV/50K	27	175	3375	125	Super White	5000K	50000	12	6.68	DL, DLC, EXF
	Box	81303-SU	CC/LED/36W/E26-E39/MV/50K	36	200	4500	125	Super White	5000K	50000	12	7.66	DL, DLC, EXF
D	Box	80582-SU	CC/LED/54W/E26-E39/MV/AMBER	54	200	4320	80	Amber Light	1700K-1900K	40000	12	10.94	DL, EXF
Mogul Base (E39)													
E	Box	81304-SU	CC/LED/45W/E39/MV/50K	45	200	5660	126	Super White	5000K	50000	12	9.5	DL, DLC, EXF
	Box	80843-SU	CC/LED/54W/E39/MV/50K	54	400	7290	135	Super White	5000K	50000	12	10.4	DL, DLC, EXF
	Box	81306-SU	CC/LED/63W/E39/MV/50K	63	500	7875	125	Super White	5000K	50000	12	10.1	DL, DLC, EXF
	Box	80844-SU	CC/LED/100W/E39/MV/50K	100	750	14000	140	Super White	5000K	50000	6	12.83	DL, DLC, EXF
	Box	80845-SU	CC/LED/125W/E39/MV/50K	125	900	18400	147	Super White	5000K	50000	6	14.2	DL, DLC, EXF

DL = Rated Damp Location DLC = DLC Approved EXF = Rated for Enclosed Fixture



High Lumen Lamps

High Bay lamp

- 80 CRI
- 120 -277Volts



A



B



C

SUPER WHITE

**5000
KELVIN**

At 5000 Kelvin, the bulbs deliver bright, clearer color to brighten larger spaces. Suitable to warehouse, parking lot, gym, garage or other large area that requires great lighting.

Super Bright

Great Energy Saver

Long Lifespan

Easy to Install

PKG	Item#	Description	Watt	Eq.W	Lumen	LPW	Color	Kelvin	Hours	Carton	MOL (IN)	Features	
Medium Screw (E26)													
A	Box	80116-SU	HL/LED/T32/E26/24W/50K	24	150	2700	113	Super White	5000K	25000	20	6.89	DL
	Box	80117-SU	HL/LED/T36/E26/32W/50K	32	175	3600	113	Super White	5000K	25000	12	8.27	DL
	Box	80123-SU	HL/LED/T36/E26/40W/50K	40	200	4800	120	Super White	5000K	25000	12	8.27	DL
B	Box	80118-SU	HL/LED/T36/E26/51W/50K	51	300	6000	118	Super White	5000K	25000	8	7.8	DL
	Box	81006-SU	HL/LED/T42/E26/70W/50K	70	500	8000	114	Super White	5000K	25000	8	8.9	DL
	Box	81007-SU	HL/LED/T42/E39/90W/50K	90	600	10000	111	Super White	5000K	25000	8	10.35	DL
Mogul Screw (E39)													
C	Box	80869-SU	HBR/LED/60W/E39/50K	60	400	7200	120	Super White	5000K	50000	6	9.06	DL, DLC
	Box	80867-SU	HBR/LED/75W/E39/50K	75	550	9000	120	Super White	5000K	50000	4	10.83	DL, DLC
	Box	80868-SU	HBR/LED/120W/E39/50K	120	750	15000	125	Super White	5000K	50000	4	12.05	DL, DLC
	Box	80870-SU	HBR/LED/160W/E39/50K	160	1000	20000	125	Super White	5000K	50000	4	13.8	DL, DLC

UFO Fixtures

Colored Pendant Fixture

- Durable 3' Threaded Cord
- UL Listed
- Bulb Sold Separately

Item#	Description	Watt	W	H	D
80758-SU	CO/PD/BL	Blue	1.80"	42.00"	1.80"
80759-SU	CO/PD/PK	Pink	1.80"	42.00"	1.80"
80760-SU	CO/PD/WH	White	1.80"	42.00"	1.80"



Utility Lamps

- Utility
- Medium Screw (E26)
- 80 CRI
- 120 Volts



	PKG	Item#	Description	Watt	Eq.W	Lumen	LPW	Color	Kelvin	Hours	Carton	MOL (IN)	Features
A	Box	80768-SU	UFO/LED/15W/30K/CH/ACRLC	15	75	1100	73	Warm White	3000K	25000	6/24	2.6	
B	Box	80762-SU	UFO/LED/7W/30K/BLUE	7	35	550	79	Warm White	3000K	25000	6/24	2.5	DL
	Box	80764-SU	UFO/LED/11W/30K/BLUE	11	50	800	73	Warm White	3000K	25000	6/24	2.6	DL
	Box	80766-SU	UFO/LED/15W/30K/BLUE	15	75	1250	83	Warm White	3000K	25000	6/24	3	DL
C	Box	80763-SU	UFO/LED/7W/30K/PINK	7	35	550	79	Warm White	3000K	25000	6/24	2.5	DL
	Box	80765-SU	UFO/LED/11W/30K/PINK	11	50	800	73	Warm White	3000K	25000	6/24	2.6	DL
	Box	80767-SU	UFO/LED/15W/30K/PINK	15	75	1250	83	Warm White	3000K	25000	6/24	3	DL

TERMS & CONDITIONS

OPEN ACCOUNT

New accounts are subject to approval. For credit applications, customers should submit a Sunlite credit application, and allow two weeks for processing. You will be notified accordingly.

PAYMENT TERMS

Net 30 days subject to credit approval. All past due invoices are subject to a 2.5% interest charge, each month the invoice remains unpaid. C.O.D. A check must be presented to the courier upon delivery of all C.O.D. shipments. All C.O.D. fees are the responsibility of the customer. Drop shipment service is not available on C.O.D. orders.

MINIMUM ORDER

There is a \$100 minimum order. Orders under \$100 will be charged a \$10 small order charge.

SPECIAL ORDER

Special order are non-returnable and non-refundable. Once the order is confirmed, a special cannot be cancelled. Please take note of items that are a special order.

DAMAGES/SHORTAGES

Claims for Shortage or shipments, must be claimed within 72 hours of receipt of the order. We regret we cannot issue credit for merchandise that has been damaged in transit. The responsibility of such damage(s) shall be taken by the carrier.

ADDING TO AN ORDER

We will do our best to add to an existing order. However, if it's not possible, we will treat it as a new order and must comply with all terms of a new order.

BACK ORDERS

All back orders will be shipped as soon as possible. If the customer has a "NO BACK ORDER POLICY", it must be communicated at the time the order is placed. If original order is subject to freight allowance, and backorder falls below minimum freight allowed, the back order shipment may be subject to freight charges.

CANCELING AN ORDER

We will try to comply with your request to cancel an order. However, we can't be responsible for cancellations. Canceling an order may be subject to a restocking charge, depending on the status of the order in our system.

SHIPPING & DROP-SHIP

We provide FREE delivery in the local N.Y. Tri-State area with minimum order. A charge will be applied to shipments delivered to a destination other than the customer's physical location for orders less than \$350. Any damages or additional standard fees (e.g. handling charge, re-delivery charge, etc...), are at the sole responsibility of the ordering customer.

FREIGHT

All shipments are FOB Brooklyn, NY. Full freight is allowed on orders totaling \$1,000.00 or more for product delivering east of the Mississippi, and \$1,200.00 for orders delivering west of the Mississippi. Freight charges which were originally allowed, may be added to an outstanding invoice that is not paid within its allowed terms (usually 30 days). The freight allowance EXCLUDES any oversized boxes that are greater than four feet (i.e. 4 ft. fluorescent lamps, fixtures, etc...).

HANDLING FEES

For all FedEx, UPS, USPS and other express services shipped on customer's personal accounts and 3rd party accounts, each order is subject to as much as a \$6.50 handling charge per box based on dimensional weight.

PACKAGING

All packages are packed with great care using the best packing methods available. If damages occur in transit, "DO NOT REFUSE THE SHIPMENT." It will cause unnecessary shipping expenses and delays in your order. File a claim with the courier for the loss or damage. The courier is responsible for breakage during transit. We will try to assist you in collecting your claims for loss or damage.

RETURNS

A written RMA must accompany all returns. A restocking charge may apply to all returned merchandise.

PRICES

Prices are subject to change without any notice.

SPECIFICATIONS

Due to the rapid advancement of LED technology, specifications are subject to change without notice.

PRODUCT & DESCRIPTIONS

We are not responsible for any typographical errors.

SIZES & MEASUREMENTS

All sizes and measurements are in inches, except where specified. Actual product sizes may vary.

WARRANTY

Sunshine Lighting, Inc. (Sunlite) warrants most of our LED products for a period of one to five (1-5) years from the date of delivery (specific to the individual product warranty on the packaging or available at www.sunlite.com) provided that said products have been installed and maintained in accordance with Sunlite's installation instructions. This warranty is limited to the repair or replacement of defective material or entire product and shall be determined at the discretion of the manufacturer as to what action is taken.

This warranty is limited to the product specifically and in no means warrants any incurred labor costs by any party involved.

Sunlite extends its warranty to the immediate buyer.

The immediate buyer must receive a Return Material Authorization (RMA) number prior to the return and the return must be visibly marked with the RMA number and the product must be returned (shipping prepaid) to Sunlite at 744 Clinton St. Brooklyn, NY. 11231.

The return must be within 30 days of receiving the RMA from Sunlite.

The warranty is subject to the following provisions:

A liability under this warranty is limited to free repair or replacement (at the manufacturers' discretion) of any operational defect and shall not extend to any other damages in connection to the misuse or mishandling of said product.

The warranty shall not apply to units which have not been handled in accordance with normal conditions of use, or units which have been subsequently processed or modified in any way, or units which have been subject to any damage affecting the overall operation of the Sunlite product.

Sunlite warranties on component parts of materials not manufactured by Sunlite may differ from the terms specified herein and will supersede Sunlite's warranty.

The manufacturers' liability will also not apply in cases where defects are not reported within 30 days after they have become recognizable by the initial buyer or by the users of the product.

***Building and safety codes vary widely throughout the world. Sunlite does not control nor will it be responsible for the selection of product supplied by others, configurations, or the installation of the product in a ceiling, wall or other area. Sunlite makes no other warranties or representation, either expressed or implied, concerning product fitness for a particular purpose. Sunlite will fabricate to dimensions shown on Sunlite supporting documentation but will not take responsibility for failure of submitting party(s) shop drawing dimensions against job site conditions. In no event will Sunlite be liable for direct, indirect, special or consequential damages including but not limited to loss of profit or use. Sunlite reserves the right to inspect or have returned all products alleged to be defective excluding shipping and handling costs. Sunlite makes no other warranty, expressed or implied, regardless of product. ***

Sunshine Lighting
744 Clinton Street
Brooklyn, NY 11231



Lighting America one bulb at a time

